



**LOS ANGELES REGION
UNIFORM CODE PROGRAM**

**RECOMMENDED TECHNICAL
AMENDMENTS TO THE
2010 CALIFORNIA BUILDING CODE,
2010 CALIFORNIA RESIDENTIAL CODE,
AND
2010 CALIFORNIA GREEN BUILDING
STANDARDS CODE**

Final Draft: August 26, 2010

PREPARED BY:



**ICC LOS ANGELES BASIN CHAPTER'S
STRUCTURAL CODE COMMITTEE,
CRC CODE COMMITTEE, AND
GREEN BUILDING STANDARDS CODE COMMITTEE.**

PREFACE

In 1957 our founding members established one of the earliest chapters of the International Conference of Building Officials and now the International Code Council. Today the Chapter has grown to over eighty-nine Southern California jurisdictions, plus consulting firms and members of the construction industry. When ICBO merged with two other building official organizations to create the International Code Council, the Los Angeles Basin Chapter officially became an ICC Chapter in December 2002.

With the recent change of the model codes from the Uniform Codes to the International Codes, the ICC Los Angeles Basin Chapter has been very active throughout the years in leading the effort to create uniformity of building codes and regulations in the greater Los Angeles region as well as addressing policy issues of interest to building officials and the construction industry.

One such effort to promote uniformity of building regulations is through the Los Angeles Regional Uniform Code Program (LARUCP). The LARUCP program began in July 1999 with the purpose of developing uniform interpretations and handouts to serve as guidelines for building officials, contractors, engineers and architects in the consistent application of the codes. The mission of this program was to minimize the number of and to develop uniformity in local technical amendments to model codes for adoption by jurisdictions in the greater Los Angeles region.

Leading the efforts to creating uniformity of building codes and regulations within the region are the dedicated members of the Los Angeles County Building and Safety Division, City of Los Angeles Department of Building and Safety, City of Long Beach Building and Safety Bureau, and other jurisdictional members in the greater Los Angeles region. Through the coordination of the ICC Los Angeles Basin Chapter's CRC Committee, Structural Code Committee, and Green Building Standards Committee, the following regulatory streamlining tasks to be completed are:

1. Create uniformity of building, plumbing, mechanical, electrical, energy efficiency and green codes that can be adopted in most of the jurisdictions in the greater Los Angeles region.
2. Reduces the total number of local technical amendments to the model code in the greater Los Angeles region.
3. Received support from most, if not all, of the 89 jurisdictions in the greater Los Angeles region.
4. Obtain active participation from a majority of the jurisdictions in the greater Los Angeles region in formulating and implementing this program.
5. With construction valuation of over \$5 billion in the region, conservatively assuming that this program produces a 1% construction cost savings, achieve an estimated cost saving of \$50 million per year in the greater Los Angeles region.

DISCUSSION

Section 17958 of the California Health and Safety Code requires that the latest California Building Standards Codes apply to local construction 180 days after they become effective at the State level. The California Building Standards Commission has adopted the 2010 Edition of the California Building Code, California Residential Code, and California Green Building Standards Code. State Law requires that these Codes become effective at the local level on January 1, 2011.

State Law requires that local amendments to the California Building Standards Codes be enacted only when an express finding is made that such modifications or changes are reasonably necessary because of local climatic, geological or topographical conditions.

The ICC Los Angeles Basin Chapter's CRC Committee, Structural Committee, and Green Building Standards Committee are recommending that the FY 2010 LARUCP Recommended Technical

FY 2010 LOS ANGELES REGION UNIFORM CODE PROGRAM (LARUCP)

Amendments contained in this document, some of which continues amendments enacted during the previous code adoption cycle, be considered for local adoption for the following reasons:

1. To protect the community within the greater Los Angeles region from a vast array of fault systems capable of producing major earthquakes and/or climate systems capable of producing major winds, fire and rain related disaster.
2. To ensure and encourage energy efficiency and sustainable practices are incorporated into building designs and constructions.

The FY 2010 LARUCP Recommended Technical Amendments have been widely circulated and/or discussed over the past several months with various local jurisdictional members, structural engineering associations or committees such as, but not limited to, Seismology, Steel, Light Frame Construction, Quality Assurance and Building Code Committee, design professionals in the construction/engineering industry, and other interested groups or individuals. The proposed languages, reasons and findings as to climatic, topographic or geologic conditions are detailed in this document for each of the recommended technical amendments to the model code.

STATEMENT ON USE OF DOCUMENT

The primary purpose of the ICC Los Angeles Basin Chapter's Committees is to serve and benefit its members. To this end, the Committees provides a forum for the exchange, consideration, and discussion of ideas and proposals that are relevant to the construction industry and the consensus of which forms the basis for the proposed amendments contained in this document.

By making available the recommendations in this document, the ICC Los Angeles Basin Chapter's Committees does not insure any jurisdiction using the information it contains against any liability arising from that use. The Committees disclaims liability for any injury to persons or to property, or other damages of any nature whatsoever, whether special, indirect, consequential or compensatory, directly or indirectly resulting from the publication, use of, or reliance on this document. The Committees makes no guaranty or warranty as to the accuracy or completeness of any information provided herein. Any jurisdiction using this document should rely on their own independent judgment and exercise reasonable care in any given circumstances. Each jurisdiction adopting the proposed amendments contained in this document should make an independent, substantiating investigation of the validity of that information for their particular use.

ACKNOWLEDGEMENT

The ICC Los Angeles Basin Chapter would like to express its gratitude and appreciation to all the participating committee members and correspondents that spent countless hours over the past several months assisting in the review, discussion, evaluation and drafting of the proposed recommended technical amendments to the 2010 Edition of the California Building Code, 2010 Edition of the California Residential Code and 2010 Edition of the California Green Building Standards Code. Special thanks go out to the following individuals without whose support and effort the recommendations presented herein would not be possible.

Addison Smith, JAS Pacific, Inc.
Amir Zamanian, IAPMO-ES
Ben Schmid, Consulting Structural Engineer
Bill Stutsman, City of Los Angeles Building and Safety Department
Bill Wang, City of Santa Monica Building and Safety Division
Carol Jacobson, City of Manhattan Beach Building and Safety
Casey Hemmatyar, SEAOSC Seismology Committee
Catherine Gaba, City of Los Angeles Building and Safety Department
CC Kim, City of Beverly Hills Building and Safety Bureau
Charles Russell, VCA Code Group

FY 2010 LOS ANGELES REGION UNIFORM CODE PROGRAM (LARUCP)

Chon Cervantes, City of Monrovia Building and Safety
Craig Earl, City of Lancaster Building and Safety Division
Craig Johnson, City of Culver City Building and Safety Division
Denise (Dee) Fukaye, City of Malibu Building and Safety
Eddie Yamamoto, City of Simi Valley Building and Safety Division
Erik Keshishian, City of Beverly Hills Building and Safety Bureau
Fady Mattar, JAS Pacific, Inc.
Forest D. Nishiyoka, City of Torrance Building and Safety Division
Fouad Barakat, County of Los Angeles Building and Safety Division
Gene Logan, City of Baldwin Park Building and Safety
Grace Harper, City of Los Angeles Building and Safety Department
Hassan Alameddine, County of Los Angeles Building and Safety Division
Jae Lee, JLee Engineering
James Lai, SEAOSC Seismology Committee
Jameson Lee, City of Los Angeles Building and Safety Department
Jesse De Anda, City of Beverly Hills
Joe Valancius, SEAOSC Seismology Committee
Jonathan Lam, County of Los Angeles Building and Safety Division
Juan Madrigal, County of Los Angeles Building and Safety Division
Kermit Robinson, ICC Staff
Larry Lee, City of Los Angeles Building and Safety Department
Leslie Trujillo, City of Los Angeles Building and Safety Department
Linda Haines, City of Downey Building and Safety
Mandhir Singh, City of Inglewood Building and Safety
Mark Lyum, NBC Universal
Marty Moreno, County of Los Angeles Building and Safety Division
Matthew Gatewood, City of Los Angeles Fire Department
Mazen Dudar, County of Los Angeles Building and Safety Division
Osama Younan, City of Los Angeles Building and Safety Department
Paul Armstrong, Interwest Consulting Group
Pedro Montenegro, Kivotos Montenegro Partners
Philip Yin, City of Long Beach Building and Safety Bureau
Richard Hess, Hess Engineering
Rick Skosnik, City of Beverly Hills Building and Safety Bureau
Ritchie Kato, CSG Consultants
Ron Takiguchi, City of Santa Monica Building and Safety Division
Sarkis Hairapetian, City of Glendale Building and Safety Division
Sarkis Nazerian, City of Pasadena Building and Safety
Steve Cloke, SEAOSC Seismology Committee
Steve Ikkanda, JAS Pacific, Inc.
Steve Lam, County of Los Angeles Building and Safety Division
Steve Widmayer, Willdan Engineering
Stuart Tom, City of Glendale Building and Safety Division
Tim Griffith, City of Los Angeles Building and Safety Department
Tim Kaucher, Simpson Strong-Tie Co.
Tim Wang, City of Los Angeles Building and Safety Department
Timothy Koutsouros, VCA Code Group
Tom Stevens, City of Los Angeles Building and Safety Department
Tom Van Dorpe, SEAOSC Light-Frame Systems Committee
Tracy Tam, City of Burbank Building and Safety
Truong Huynh, City of Long Beach Building and Safety Bureau
Victor Cuevas, City of Los Angeles Building and Safety Department
Yung Kao, City of Monterey Park Building and Safety

TABLE OF CONTENT

<u>TITLE/DESCRIPTION</u>	<u>PAGE</u>
Preface	2
Discussion	2
Statement on Use of Document	3
Acknowledgement	3
Table of Content	5
 PART I	 7
Summary of Recommended LARUCP Amendments to the 2010 CBC	8
2010 LARUCP 16-01 Amend CBC Section 1613.6.1 Assumption of Flexible Diaphragm	9
2010 LARUCP 16-02 Amend CBC Section 1613.6.7 Building Separation	10
2010 LARUCP 16-03 Add CBC Section 1613.8 BRBF Period Parameter	11
2010 LARUCP 16-04 Add CBC Section 1613.9 Values for Vertical Combinations	12
2010 LARUCP 16-05 Add CBC Section 1613.10 Stability Coefficient	13
2010 LARUCP 16-06 Add CBC Section 1613.11 Subdiaphragm	14
2010 LARUCP 16-07 Add CBC Section 1613.12 Hillside Building	15
2010 LARUCP 16-08 Add CBC Section 1613.13 Suspended Ceiling	22
2010 LARUCP 17-01 Amend CBC Section 1704.4 SI for Concrete Construction	24
2010 LARUCP 17-02 Amend CBC Section 1704.8 Driven Deep Foundations	25
2010 LARUCP 17-03 Amend CBC Section 1704.9 Cast-in-Place Deep Foundations	26
2010 LARUCP 17-04 Amend CBC Section 1705.3 Seismic Resistance Inspection	27
2010 LARUCP 17-05 Amend CBC Section 1710.1 Structural Observations General	28
2010 LARUCP 17-06 Amend CBC Section 1710.2 Structural Observations Seismic	30
2010 LARUCP 18-01 Amend CBC Section 1807.1.4 Permanent Wood Foundation Systems	31
2010 LARUCP 18-02 Amend CBC Section 1807.1.6 Prescriptive Design of Foundation Walls	32
2010 LARUCP 18-03 Amend CBC Section 1809.3 Stepped Footings	33
2010 LARUCP 18-04 Amend CBC Table 1809.7 Prescriptive Footings	34
2010 LARUCP 18-05 Amend CBC Section 1809.12 Timber Footings	35
2010 LARUCP 18-06 Amend CBC Section 1810.3.2.4 Timber	36
2010 LARUCP 19-01 Add CBC Sections 1908.1.11 thru 14 Reinforcement	37
2010 LARUCP 19-02 Amend CBC Section 1908.1.2 Intermediate Structural Wall	39
2010 LARUCP 19-03 Amend CBC Section 1908.1.3 Wall Pier	40
2010 LARUCP 19-04 Amend CBC Section 1908.1.8 Minimum Reinforcement	42
2010 LARUCP 19-05 Amend CBC Section 1909.4 Structural Plain Concrete Design	44
2010 LARUCP 22-01 Add CBC Section 2204.1.1 Consumables for Welding	45
2010 LARUCP 22-02 Add CBC Section 2205.4 SCBF Member Type	47
2010 LARUCP 23-01 Amend CBC Section 2304.11.7 Wood Used in Retaining Wall	48
2010 LARUCP 23-02 Add CBC Section 2305.4 Quality of Nails	49
2010 LARUCP 23-03 Add CBC Section 2305.5 Hold-down Connectors	50
2010 LARUCP 23-04 Amend CBC Section 2306.2.1 Wood Diaphragm	51
2010 LARUCP 23-05 Amend CBC Section 2306.3 Wood Shear Walls	57
2010 LARUCP 23-06 Amend CBC Section 2306.7 Other Shear Walls	61
2010 LARUCP 23-07 Amend CBC Section 2308.3.4 Brace Wall Line Support	62
2010 LARUCP 23-08 Amend CBC Section 2308.12.2 Concrete or Masonry	63
2010 LARUCP 23-09 Amend CBC Section 2308.12.4 Braced Wall Sheathing	64
2010 LARUCP 23-10 Amend CBC Section 2304.9.1 Fastener Requirement	66
2010 LARUCP 23-11 Amend CBC Section 2308.12.5 Attachment of Sheathing	67

FY 2010 LOS ANGELES REGION UNIFORM CODE PROGRAM (LARUCP)

PART II	68
Summary of Recommended LARUCP Amendments to the 2010 CRC	69
2010 LARUCP R3-01 Amend CRC Section R301.1.3.2 Woodframe Structures	70
2010 LARUCP R3-02 Amend CRC Section R301.1.4 Slopes Steeper Than 33%	71
2010 LARUCP R3-03 Amend CRC Section R301.2.2.2.5 Irregular Buildings	72
2010 LARUCP R3-04 Amend CRC Section R311.2.2.3.5.1 AISI S230 Section B1	74
2010 LARUCP R3-05 Amend CRC Section R322.1.4.1 Design Flood Elevations	75
2010 LARUCP R4-01 Amend CRC Section R401.1 Foundation Application	76
2010 LARUCP R4-02 Amend CRC Section R403.1 General Footings	77
2010 LARUCP R4-03 Amend CRC Section R404.2 Wood Foundation Walls	79
2010 LARUCP R5-01 Amend CRC Section R501.1 Application	80
2010 LARUCP R5-02 Amend CRC Section R503.2.4 Openings In Horizontal Diaphragms	81
2010 LARUCP R6-01 Amend CRC Table R602.3(1) Fastener Schedule	83
2010 LARUCP R6-02 Amend CRC Table R602.3(2) Alternate Attachment	84
2010 LARUCP R6-03 Amend CRC Table R602.10.1.2(2) Bracing Requirement	86
2010 LARUCP R6-04 Amend CRC Table R602.10.2 Intermittent Bracing Method	88
2010 LARUCP R6-05 Amend CRC Figure R602.10.3.2 Alternate Braced Wall Panel	90
2010 LARUCP R6-06 Amend CRC Figure R602.10.3.3 Portal Frame	91
2010 LARUCP R6-07 Amend CRC Section R602.10.3.3 Method PFH	93
2010 LARUCP R6-08 Amend CRC Table R602.10.4.1 Continuous Sheathing	94
2010 LARUCP R6-09 Amend CRC Figure R602.10.4.1.1 Method CS-PF	96
2010 LARUCP R6-10 Delete CRC Section R602.10.7.1 Braced Wall Panel	97
2010 LARUCP R6-11 Amend CRC Section R606.2.4 Parapet Walls	98
2010 LARUCP R6-12 Amend CRC Section R606.12.2.2.3 Reinforcement for Masonry	99
2010 LARUCP R6-13 Amend CRC Section R602.3.2 Single Top Plate	100
2010 LARUCP R8-01 Amend CRC Table R802.5.1(9) Joist Heel Joint Connection	101
2010 LARUCP R8-02 Amend CRC Section R802.8 Lateral Support	102
2010 LARUCP R8-03 Amend CRC Section R802.10.2 Design of Wood Trusses	103
2010 LARUCP R8-04 Add CRC Section R803.2.4 Openings in Horizontal Diaphragms	104
2010 LARUCP R10-01 Amend CRC Section R1001.3.1 Vertical Reinforcing	105
PART III	106
Summary of Recommended LARUCP Amendments to the 2010 CGBSC	107
2010 LARUCP G1-01 Amend CGBSC Section 101.10 Mandatory and Voluntary Requirements	108
2010 LARUCP G1-02 Add CGBSC Section 101.12 Fee for Mandatory Measures	109
2010 LARUCP G1-03 Add CGBSC Section 101.12.1 Fee for Tier Measures	110
2010 LARUCP G2-01 Amend CGBSC Section 202 Sustainability Definition	111
2010 LARUCP G2-02 Amend CGBSC Section 202 Low-Rise Residential Building Definition	112
2010 LARUCP G4-01 Amend CGBSC Section 4.304.1 Irrigation Controller	113
2010 LARUCP G4-02 Amend CGBSC Section 4.408 Construction Waste Reduction	114

PART I

RECOMMENDED LARUCP AMENDMENTS TO THE 2010 EDITION OF THE CALIFORNIA BUILDING CODE

SUMMARY OF RECOMMENDED LARUCP AMENDMENTS TO THE 2010 CBC

(N) 2010 LARUCP NO.	(E) 2007 LARUCP NO.	TITLE/DESCRIPTION	STATUS ¹	DATE
16-01	16-01	Amend CBC Section 1613.6.1 Assumption of Flexible Diaphragm	AM	5/25/10
16-02	16-10	Amend CBC Section 1613.6.7 Building Separation	AM	4/27/10
16-03	16-07	Add CBC Section 1613.8 BRBF Period Parameter	AS	4/27/10
16-04	16-04	Add CBC Section 1613.9 Values for Vertical Combinations	AS	4/27/10
16-05	16-08	Add CBC Section 1613.10 Stability Coefficient	AS	4/27/10
16-06	16-02	Add CBC Section 1613.11 Subdiaphragm	AM	4/27/10
16-07	16-03	Add CBC Section 1613.12 Hillside Building	AM	6/14/10
16-08	16-09	Add CBC Section 1613.13 Suspended Ceiling	AM	5/25/10
17-01	17-02	Amend CBC Section 1704.4 SI for Concrete Construction	AM	4/27/10
17-02	17-03	Amend CBC Section 1704.8 Driven Deep Foundations	AS	5/25/10
17-03	17-03	Amend CBC Section 1704.9 Cast-in-Place Deep Foundations	AS	5/25/10
17-04	17-01	Amend CBC Section 1705.3 Seismic Resistance Inspection	AM	4/27/10
17-05	17-04	Amend CBC Section 1710.1 Structural Observations General	AM	4/27/10
17-06	17-04	Amend CBC Section 1710.2 Structural Observations Seismic	AM	4/27/10
18-01	18-01	Amend CBC Section 1807.1.4 Permanent Wood Foundation System	AS	4/27/10
18-02	18-01	Amend CBC Section 1807.1.6 Prescriptive Design of Foundation Walls	AS	4/27/10
18-03	18-01	Amend CBC Section 1809.3 Stepped Footings	AS	4/27/10
18-04	18-01	Amend CBC Table 1809.7 Prescriptive Footings	AS	4/27/10
18-05	18-01	Amend CBC Section 1809.12 Timber Footings	AS	4/27/10
18-06	18-01	Amend CBC Section 1810.3.2.4 Timber	AS	4/27/10
19-01	19-02	Add CBC Sections 1908.1.11 thru 14 Reinforcement	AS	4/27/10
19-02	N/A	Amend CBC Section 1908.1.2 Intermediate Structural Wall	AS	4/27/10
19-03	N/A	Amend CBC Section 1908.1.3 Wall Pier	AS	4/27/10
19-04	19-03	Amend CBC Section 1908.1.8 Minimum Reinforcement	AS	4/27/10
19-05	N/A	Amend CBC Section 1909.4 Structural Plain Concrete Design	AM	6/14/10
22-01	N/A	Add CBC Section 2204.1.1 Consumables for Welding	AS	4/27/10
22-02	22-01	Add CBC Section 2205.4 SCBF Member Type	AS	4/27/10
23-01	N/A	Amend CBC Section 2304.11.7 Wood Used in Retaining Wall	AM	5/11/10
23-02	23-03	Add CBC Section 2305.4 Quality of Nails	AS	5/11/10
23-03	23-02	Add CBC Section 2305.5 Hold-down Connectors	AM	5/11/10
23-04	23-04	Amend CBC Section 2306.2.1 Wood Diaphragm	AM	5/11/10
23-05	23-04	Amend CBC Section 2306.3 Wood Shear Walls	AM	6/24/10
23-06	23-05	Amend CBC Section 2306.7 Other Shear Walls	AM	6/24/10
23-07	N/A	Amend CBC Section 2308.3.4 Brace Wall Line Support	AM	5/11/10
23-08	23-06	Amend CBC Section 2308.12.2 Concrete or Masonry	AM	5/11/10
23-09	23-06	Amend CBC Section 2308.12.4 Braced Wall Sheathing	AM	6/14/10
23-10	N/A	Amend CBC Section 2304.9.1 Fastener Requirement	AM	6/14/10
23-11	23-06	Amend CBC Section 2308.12.5 Attachment of Sheathing	AM	5/11/10

FOOTNOTE:

1. AS = Approved as submitted. AM = Approved as modified. N/A = Not Applicable.

2010 LARUCP 16-01. Section 1613.6.1 of the 2010 Edition of the California Building Code is amended to read as follows:

1613.6.1 Assumption of flexible diaphragm. Add the following text at the end of Section 12.3.1.1 of ASCE 7:

Diaphragms constructed of wood structural panels or untopped steel decking shall also be permitted to be idealized as flexible, provided all of the following conditions are met:

1. Toppings of concrete or similar materials are not placed over wood structural panel diaphragms except for nonstructural toppings no greater than 1 ½ inches (38 mm) thick.
2. Each line of vertical elements of the seismic-force-resisting system complies with the allowable story drift of Table 12.12-1.
3. Vertical elements of the seismic-force-resisting system are light-framed walls sheathed with wood structural panels rated for shear resistance or steel sheets.
4. Portions of wood structural panel diaphragms that cantilever beyond the vertical elements of the ~~lateral~~ seismic-force-resisting system are designed in accordance with Section 4.2.5.2 of AF&PA SDPWS.

RATIONALE:

This proposed amendment changes “lateral” to “seismic” to reflect consistency of the application of this provision.

FINDINGS:

Local Geological Conditions – The greater Los Angeles region is a densely populated area having buildings and structures constructed over and near a vast array of fault systems capable of producing major earthquakes, including but not limited to the recent 1994 Northridge Earthquake. The proposed modification emphasize that the design concern is for seismic-force-resisting elements and therefore need to be incorporated into the code to assure that new buildings and structures and additions or alterations to existing buildings or structures are designed and constructed in accordance with the scope and objectives of the International Building Code.

2010 LARUCP 16-02. Equation 16-44 of Section 1613.6.7 of the 2010 Edition of the California Building Code is amended to read as follows:

$$\delta_M = \frac{C_d \delta_{max}}{I} \quad \text{(Equation 16-44)}$$

where:

C_d = Deflection amplification factor in Table 12.2-1 of ASCE 7.

δ_{max} = Maximum displacement defined in Section 12.8.4.3 of ASCE 7.

~~I = Importance factor in accordance with Section 11.5.1 of ASCE 7.~~

RATIONALE:

The inclusion of the importance factor in this equation has the unintended consequence of reducing the minimum seismic separation distance for important facilities such as hospital, school, police and fire station, etc. from adjoining structures. The proposal to omit the importance factor from Equation 16-44 will ensure that a safe seismic separation distance is provided. This proposed amendment is a continuation of an amendment adopted during previous code adoption cycles.

FINDINGS:

Local Geological Conditions – The greater Los Angeles region is a densely populated area having buildings and structures constructed over and near a vast array of fault systems capable of producing major earthquakes, including but not limited to the recent 1994 Northridge Earthquake. The proposed modification to omit the importance factor in the equation ensures that a safe seismic separation distance is maintained for important facilities from adjoining structures and therefore need to be incorporated into the code to assure that new buildings and structures and additions or alterations to existing buildings or structures are designed and constructed in accordance with the scope and objectives of the International Building Code.

FY 2010 LOS ANGELES REGION UNIFORM CODE PROGRAM (LARUCP)

2010 LARUCP 16-03. Section 1613.8 is added to Chapter 16 of the 2010 Edition of the California Building Code to read as follows:

1613.8 ASCE 7, Table 12.8-2. Modify ASCE 7 Table 12.8-2 by adding the following:

Structure Type	C_t	x
Eccentrically braced steel frames and buckling-restrained braced frames	0.03 (0.0731) ^a	0.75

RATIONALE:

The steel Buckling Restrained Braced Frame (BRBF) system was first approved for use in the 2003 NEHRP Provisions. The values for the approximate period perimeters C_t and x were also approved as part of that original BSSC Proposal 6-6R (2003). It was an oversight that these parameters were not carried forward into the 2005 Edition of the ASCE 7. Currently, these two factors can be found in Appendix R of AISC 341-05. There, they function only as a placeholder that will be removed in the next version upon approval by ASCE 7 Task Committee on Seismic. This proposed amendment is a continuation of an amendment adopted during previous code adoption cycles.

FINDINGS:

Local Geological Conditions – The greater Los Angeles region is a densely populated area having buildings and structures constructed over and near a vast array of fault systems capable of producing major earthquakes, including but not limited to the recent 1994 Northridge Earthquake. The proposed amendment provides clarification on the design parameters for BRBF members and therefore needs to be incorporated into the code to assure that new buildings and structures and additions or alterations to existing buildings or structures are designed and constructed in accordance with the scope and objectives of the International Building Code and ASCE 7-05.

2010 LARUCP 16-04. Section 1613.9 is added to Chapter 16 of the 2010 Edition of the California Building Code to read as follows:

1613.9 ASCE 7, 12.2.3.1, Exception 3. Modify ASCE 7 Section 12.2.3.1 Exception 3 to read as follows:

3. Detached one and two family dwellings up to two stories in height of light frame construction.

RATIONALE:

Observed damages to one and two family dwellings of light frame construction after the Northridge Earthquake may have been partially attributed to vertical irregularities common to this type of occupancy and construction. In an effort to improve quality of construction and incorporate lesson learned from studies after the Northridge Earthquake, the proposed modification to ASCE 7-05 Section 12.2.3.1 by limiting the number of stories and height of the structure to two stories will significantly minimize the impact of vertical irregularities and concentration of inelastic behavior from mixed structural systems. This proposed amendment is a continuation of an amendment adopted during previous code adoption cycles.

FINDINGS:

Local Geological Conditions – The greater Los Angeles region is a densely populated area having buildings and structures constructed over and near a vast array of fault systems capable of producing major earthquakes, including but not limited to the recent 1994 Northridge Earthquake. The proposed modification to limit mixed structural system to two stories is intended to improve quality of construction by reducing potential damages that may result from vertical irregularities of the structural system in buildings subject to high seismic load and therefore need to be incorporated into the code to assure that new buildings and structures and additions or alterations to existing buildings or structures are designed and constructed in accordance with the scope and objectives of the International Building Code.

2010 LARUCP 16-05. Section 1613.10 is added to Chapter 16 of the 2010 Edition of the California Building Code to read as follows:

1613.10 ASCE 7, Section 12.8.7. Modify ASCE 7 Section 12.8.7 by amending Equation 12.8-16 as follows:

$$\theta = \frac{P_x \Delta I}{V_x h_{sx} C_d} \quad (12.8-16)$$

RATIONALE:

The importance factor, I, was dropped from equation 12.8-16 by mistake while transcribing it from NEHRP Recommended Provisions (2003) equation 5.2-16. For buildings with importance factor, I, higher than 1.0, stability coefficient should include the importance factor. The proposed modification is consistent with the provisions adopted by OSPHD and DSA-SS as reflected in Section 1615.10.5 of the 2010 California Building Code. SEAOSC Steel Committee had supported the proposed modification during the 2007 code adoption process. This proposed amendment is a continuation of an amendment adopted during previous code adoption cycles.

FINDINGS:

Local Geological Conditions – The greater Los Angeles region is a densely populated area having buildings and structures constructed over and near a vast array of fault systems capable of producing major earthquakes, including but not limited to the recent 1994 Northridge Earthquake. The proposed modification is intended to improve the likelihood that important and critical buildings and structures remain operational in the event of an emergency resulting from seismic activities and therefore need to be incorporated into the code to assure that new buildings and structures and additions or alterations to existing buildings or structures are designed and constructed in accordance with the scope and objectives of the International Building Code.

2010 LARUCP 16-06. Section 1613.11 is added to Chapter 16 of the 2010 Edition of the California Building Code to read as follows:

1613.11 ASCE 7, Section 12.11.2.2.3. Modify ASCE 7, Section 12.12.4 to read as follows:

12.11.2.2.3 Wood Diaphragms. In wood diaphragms, the continuous ties shall be in addition to the diaphragm sheathing. Anchorage shall not be accomplished by use of toe nails or nails subject to withdrawal nor shall wood ledgers or framing be used in cross-grain bending or cross-grain tension. The diaphragm sheathing shall not be considered effective as providing ties or struts required by this section.

For structures assigned to Seismic Design Category D, E or F, wood diaphragms supporting concrete or masonry walls shall comply with the following:

1. The spacing of continuous ties shall not exceed 40 feet. Added chords of diaphragms may be used to form subdiaphragms to transmit the anchorage forces to the main continuous crossties.
2. The maximum diaphragm shear used to determine the depth of the subdiaphragm shall not exceed 75% of the maximum diaphragm shear.

RATIONALE:

A joint Structural Engineers Association of Southern California (SEAOSC), Los Angeles County and Los Angeles City Task Force investigated the performance of concrete and masonry construction with flexible wood diaphragm failures after the Northridge earthquake. It was concluded at that time that continuous ties are needed at specified spacing to control cross grain tension in the interior of the diaphragm. Additionally, there was a need to limit subdiaphragm allowable shear loads to control combined orthogonal stresses within the diaphragm. Recognizing the importance and need to continue the recommendation made by the task force while taking into consideration the improve performances and standards for diaphragm construction today, this proposal increases the continuous tie spacing limit to 40 ft in lieu of 25 ft and to use 75% of the allowable code diaphragm shear to determine the depth of the subdiaphragm in lieu of the 300 plf and is deemed appropriate and acceptable. Due to the frequency of this type of failure during the past significant earthquakes, various jurisdictions within the Los Angeles region have taken this additional step to prevent roof or floor diaphragms from pulling away from concrete or masonry walls. This proposed amendment is a continuation of an amendment adopted during previous code adoption cycles.

FINDINGS:

Local Geological Conditions – The greater Los Angeles region is a densely populated area having buildings and structures constructed over and near a vast array of fault systems capable of producing major earthquakes, including but not limited to the recent 1994 Northridge Earthquake. The proposed modification to require special anchorage of the diaphragm to the wall and limit the allowable shear will address special needs for concrete and masonry construction with flexible wood diaphragm and therefore need to be incorporated into the code to assure that new buildings and structures and additions or alterations to existing buildings or structures are designed and constructed in accordance with the scope and objectives of the International Building Code.

2010 LARUCP 16-07. Section 1613.12 is added to Chapter 16 of the 2010 Edition of the California Building Code to read as follows:

1613.12 Seismic Design Provisions for Hillside Buildings.

1613.12.1 Purpose. The purpose of this section is to establish minimum regulations for the design and construction of new buildings and additions to existing buildings when constructing such buildings on or into slopes steeper than one unit vertical in three units horizontal (33.3%). These regulations establish minimum standards for seismic force resistance to reduce the risk of injury or loss of life in the event of earthquakes.

1613.12.2 Scope. The provisions of this section shall apply to the design of the lateral-force-resisting system for hillside buildings at and below the base level diaphragm. The design of the lateral-force-resisting system above the base level diaphragm shall be in accordance with the provisions for seismic and wind design as required elsewhere in this division.

Exception: Non-habitable accessory buildings and decks not supporting or supported from the main building are exempt from these regulations.

1613.12.3 Definitions. For the purposes of this section certain terms are defined as follows:

BASE LEVEL DIAPHRAGM is the floor at, or closest to, the top of the highest level of the foundation.

DIAPHRAGM ANCHORS are assemblies that connect a diaphragm to the adjacent foundation at the uphill diaphragm edge.

DOWNHILL DIRECTION is the descending direction of the slope approximately perpendicular to the slope contours.

FOUNDATION is concrete or masonry which supports a building, including footings, stem walls, retaining walls, and grade beams.

FOUNDATION EXTENDING IN THE DOWNHILL DIRECTION is a foundation running downhill and approximately perpendicular to the uphill foundation.

HILLSIDE BUILDING is any building or portion thereof constructed on or into a slope steeper than one unit vertical in three units horizontal (33.3%). If only a portion of the building is supported on or into the slope, these regulations apply to the entire building.

PRIMARY ANCHORS are diaphragm anchors designed for and providing a direct connection as described in Sections 1613.12.5 and 1613.12.7.3 between the diaphragm and the uphill foundation.

SECONDARY ANCHORS are diaphragm anchors designed for and providing a redundant diaphragm to foundation connection, as described in Sections 1613.12.6 and 1613.12.7.4.

UPHILL DIAPHRAGM EDGE is the edge of the diaphragm adjacent and closest to the highest ground level at the perimeter of the diaphragm.

UPHILL FOUNDATION is the foundation parallel and closest to the uphill diaphragm edge.

1613.12.4 Analysis and Design.

1613.12.4.1 General. Every hillside building within the scope of this section shall be analyzed, designed, and constructed in accordance with the provisions of this division. When the code-

prescribed wind design produces greater effects, the wind design shall govern, but detailing requirements and limitations prescribed in this and referenced sections shall be followed.

1613.12.4.2 Base Level Diaphragm-Downhill Direction. The following provisions shall apply to the seismic analysis and design of the connections for the base level diaphragm in the downhill direction.

1613.12.4.2.1 Base for Lateral Force Design Defined. For seismic forces acting in the downhill direction, the base of the building shall be the floor at or closest to the top of the highest level of the foundation.

1613.12.4.2.2 Base Shear. In developing the base shear for seismic design, the response modification coefficient (R) shall not exceed 5 for bearing wall and building frame systems. The total base shear shall include the forces tributary to the base level diaphragm including forces from the base level diaphragm.

1613.12.5 Base Shear Resistance-Primary Anchors.

1613.12.5.1 General. The base shear in the downhill direction shall be resisted through primary anchors from diaphragm struts provided in the base level diaphragm to the foundation.

1613.12.5.2 Location of Primary Anchors. A primary anchor and diaphragm strut shall be provided in line with each foundation extending in the downhill direction. Primary anchors and diaphragm struts shall also be provided where interior vertical lateral-force-resisting elements occur above and in contact with the base level diaphragm. The spacing of primary anchors and diaphragm struts or collectors shall in no case exceed 30 feet (9144 mm).

1613.12.5.3 Design of Primary Anchors and Diaphragm Struts. Primary anchors and diaphragm struts shall be designed in accordance with the requirements of Section 1613.12.8.

1613.12.5.4 Limitations. The following lateral-force-resisting elements shall not be designed to resist seismic forces below the base level diaphragm in the downhill direction:

1. Wood structural panel wall sheathing,
2. Cement plaster and lath,
3. Gypsum wallboard, and
4. Tension only braced frames.

Braced frames designed in accordance with the requirements of Section 2205.2.2 may be used to transfer forces from the primary anchors and diaphragm struts to the foundation provided lateral forces do not induce flexural stresses in any member of the frame or in the diaphragm struts. Deflections of frames shall account for the variation in slope of diagonal members when the frame is not rectangular.

1613.12.6. Base Shear Resistance-Secondary Anchors.

1613.12.6.1 General. In addition to the primary anchors required by Section 1613.12.5, the base shear in the downhill direction shall be resisted through secondary anchors in the uphill foundation connected to diaphragm struts in the base level diaphragm.

Exception: Secondary anchors are not required where foundations extending in the downhill direction spaced at not more than 30 feet (9144 mm) on center extend up to and are directly connected to the base level diaphragm for at least 70% of the diaphragm depth.

1613.12.6.2 Secondary Anchor Capacity and Spacing. Secondary anchors at the base level diaphragm shall be designed for a minimum force equal to the base shear, including forces tributary to the base level diaphragm, but not less than 600 pounds per lineal foot (8.76 kN/m). The secondary anchors shall be uniformly distributed along the uphill diaphragm edge and shall be spaced a maximum of four feet (1219 mm) on center.

1613.12.6.3 Design. Secondary anchors and diaphragm struts shall be designed in accordance with Section 1613.12.8.

1613.12.7 Diaphragms Below the Base Level-Downhill Direction. The following provisions shall apply to the lateral analysis and design of the connections for all diaphragms below the base level diaphragm in the downhill direction.

1613.12.7.1 Diaphragm Defined. Every floor level below the base level diaphragm shall be designed as a diaphragm.

1613.12.7.2 Design Force. Each diaphragm below the base level diaphragm shall be designed for all tributary loads at that level using a minimum seismic force factor not less than the base shear coefficient.

1613.12.7.3 Design Force Resistance-Primary Anchors. The design force described in Section 1613.12.7.2 shall be resisted through primary anchors from diaphragm struts provided in each diaphragm to the foundation. Primary anchors shall be provided and designed in accordance with the requirements and limitations of Section 1613.12.5.

1613.12.7.4 Design Force Resistance-Secondary Anchors.

1613.12.7.4.1 General. In addition to the primary anchors required in Section 1613.12.7.3, the design force in the downhill direction shall be resisted through secondary anchors in the uphill foundation connected to diaphragm struts in each diaphragm below the base level.

Exception: Secondary anchors are not required where foundations extending in the downhill direction, spaced at not more than 30 feet (9144 mm) on center, extend up to and are directly connected to each diaphragm below the base level for at least 70% of the diaphragm depth.

1613.12.7.4.2 Secondary Anchor Capacity. Secondary anchors at each diaphragm below the base level diaphragm shall be designed for a minimum force equal to the design force but not less than 300 pounds per lineal foot (4.38 kN/m). The secondary anchors shall be uniformly distributed along the uphill diaphragm edge and shall be spaced a maximum of four feet (1219 mm) on center.

1613.12.7.4.3 Design. Secondary anchors and diaphragm struts shall be designed in accordance with Section 1613.12.8.

1613.12.8 Primary and Secondary Anchorage and Diaphragm Strut Design. Primary and secondary anchors and diaphragm struts shall be designed in accordance with the following provisions:

- 1. Fasteners.** All bolted fasteners used to develop connections to wood members shall be provided with square plate washers at all bolt heads and nuts. Washers shall be minimum 0.229 inch by 3 inches by 3 inches (5.82 mm by 76 mm by 76 mm) in size. Nuts shall be tightened to finger tight plus one half (1/2) wrench turn prior to covering the framing.
- 2. Fastening.** The diaphragm to foundation anchorage shall not be accomplished by the use of toenailing, nails subject to withdrawal, or wood in cross-grain bending or cross-grain tension.

3. Size of Wood Members. Wood diaphragm struts collectors, and other wood members connected to primary anchors shall not be less than three-inch (76 mm) nominal width. The effects of eccentricity on wood members shall be evaluated as required per Item 9.
4. Design. Primary and secondary anchorage, including diaphragm struts, splices, and collectors shall be designed for 125% of the tributary force.
5. Allowable Stress Increase. The one-third allowable stress increase permitted under Section 1605.3.2 shall not be taken when the working (allowable) stress design method is used.
6. Steel Element of Structural Wall anchorage System. The strength design forces for steel elements of the structural wall anchorage system, with the exception of anchor bolts and reinforcing steel, shall be increased by 1.4 times the forces otherwise required.
7. Primary Anchors. The load path for primary anchors and diaphragm struts shall be fully developed into the diaphragm and into the foundation. The foundation must be shown to be adequate to resist the concentrated loads from the primary anchors.
8. Secondary Anchors. The load path for secondary anchors and diaphragm struts shall be fully developed in the diaphragm but need not be developed beyond the connection to the foundation.
9. Symmetry. All lateral force foundation anchorage and diaphragm strut connections shall be symmetrical. Eccentric connections may be permitted when demonstrated by calculation or tests that all components of force have been provided for in the structural analysis or tests.
10. Wood Ledgers. Wood ledgers shall not be used to resist cross-grain bending or cross-grain tension.

1613.12.9 Lateral-Force-Resisting Elements Normal to the Downhill Direction.

1613.12.9.1 General. In the direction normal to the downhill direction, lateral-force-resisting elements shall be designed in accordance with the requirements of this section.

1613.12.9.2 Base Shear. In developing the base shear for seismic design, the response modification coefficient (R) shall not exceed 5 for bearing wall and building frame systems.

1613.12.9.3 Vertical Distribution of Seismic Forces. For seismic forces acting normal to the downhill direction the distribution of seismic forces over the height of the building using Section 12.8.3 of ASCE 7 shall be determined using the height measured from the top of the lowest level of the building foundation.

1613.12.9.4 Drift Limitations. The story drift below the base level diaphragm shall not exceed 0.007 times the story height at strength design force level. The total drift from the base level diaphragm to the top of the foundation shall not exceed 3/4 inch (19 mm). Where the story height or the height from the base level diaphragm to the top of the foundation varies because of a stepped footing or story offset, the height shall be measured from the average height of the top of the foundation. The story drift shall not be reduced by the effect of horizontal diaphragm stiffness.

1613.12.9.5 Distribution of Lateral Forces.

1613.12.9.5.1 General. The design lateral force shall be distributed to lateral-force-resisting elements of varying heights in accordance with the stiffness of each individual element.

1613.12.9.5.2 Wood Structural Panel Sheathed Walls. The stiffness of a stepped wood structural panel shear wall may be determined by dividing the wall into adjacent rectangular elements, subject to the same top of wall deflection. Deflections of shear walls may be estimated by AF&PA SDPWS Section 4.3.2. Sheathing and fastening requirements for the stiffest section shall be used for the entire wall. Each section of wall shall be anchored for shear and uplift at each step. The minimum horizontal length of a step shall be eight feet (2438 mm) and the maximum vertical height of a step shall be two feet, eight inches (813 mm).

1613.12.9.5.3 Reinforced Concrete or Masonry Shear Walls. Reinforced concrete or masonry shear walls shall have forces distributed in proportion to the rigidity of each section of the wall.

1613.12.9.6 Limitations. The following lateral force-resisting-elements shall not be designed to resist lateral forces below the base level diaphragm in the direction normal to the downhill direction:

1. Cement plaster and lath,
2. Gypsum wallboard, and
3. Tension-only braced frames.

Braced frames designed in accordance with the requirements of Section 2205.2.2 of this Code may be designed as lateral-force-resisting elements in the direction normal to the downhill direction, provided lateral forces do not induce flexural stresses in any member of the frame. Deflections of frames shall account for the variation in slope of diagonal members when the frame is not rectangular.

1613.12.10 Specific Design Provisions.

1613.12.10.1 Footings and Grade Beams. All footings and grade beams shall comply with the following:

1. Grade beams shall extend at least 12 inches (305 mm) below the lowest adjacent grade and provide a minimum 24-inch (610 mm) distance horizontally from the bottom outside face of the grade beam to the face of the descending slope.
2. Continuous footings shall be reinforced with at least two No. 4 reinforcing bars at the top and two No. 4 reinforcing bars at the bottom.
3. All main footing and grade beam reinforcement steel shall be bent into the intersecting footing and fully developed around each corner and intersection.
4. All concrete stem walls shall extend from the foundation and reinforced as required for concrete or masonry walls.

1613.12.10.2 Protection Against Decay and Termites. All wood to earth separation shall comply with the following:

1. Where a footing or grade beam extends across a descending slope, the stem wall, grade beam, or footing shall extend up to a minimum 18 inches (457 mm) above the highest adjacent grade.

Exception: At paved garage and doorway entrances to the building, the stem wall need only extend to the finished concrete slab, provided the wood framing is protected with a moisture proof barrier.

2. Wood ledgers supporting a vertical load of more than 100 pounds per lineal foot (1.46 kN/m) and located within 48 inches (1219 mm) of adjacent grade are prohibited. Galvanized steel ledgers and anchor bolts, with or without wood nailers, or treated or decay resistant sill plates supported on a concrete or masonry seat, may be used.

1613.12.10.3 Sill Plates. All sill plates and anchorage shall comply with the following:

1. All wood framed walls, including nonbearing walls, when resting on a footing, foundation, or grade beam stem wall, shall be supported on wood sill plates bearing on a level surface.
2. Power-driven fasteners shall not be used to anchor sill plates except at interior nonbearing walls not designed as shear walls.

1613.12.10.4 Column Base Plate Anchorage. The base of isolated wood posts (not framed into a stud wall) supporting a vertical load of 4,000 pounds (17.8 kN) or more and the base plate for a steel column shall comply with the following:

1. When the post or column is supported on a pedestal extending above the top of a footing or grade beam, the pedestal shall be designed and reinforced as required for concrete or masonry columns. The pedestal shall be reinforced with a minimum of four No. 4 bars extending to the bottom of the footing or grade beam. The top of exterior pedestals shall be sloped for positive drainage.
2. The base plate anchor bolts or the embedded portion of the post base, and the vertical reinforcing bars for the pedestal, shall be confined with two No. 4 or three No. 3 ties within the top five inches (127 mm) of the concrete or masonry pedestal. The base plate anchor bolts shall be embedded a minimum of 20 bolt diameters into the concrete or masonry pedestal. The base plate anchor bolts and post bases shall be galvanized and each anchor bolt shall have at least two galvanized nuts above the base plate.

1613.12.10.5 Steel Beam to Column Supports. All steel beam to column supports shall be positively braced in each direction. Steel beams shall have stiffener plates installed on each side of the beam web at the column. The stiffener plates shall be welded to each beam flange and the beam web. Each brace connection or structural member shall consist of at least two 5/8 inch (15.9 mm) diameter machine bolts.

RATIONALE:

Due to the difficulty of fire suppression vehicles accessing winding and narrow hillside properties and the probabilities for future earthquakes in the Los Angeles region, this technical amendment is required to address the special needs for buildings constructed on hillside locations. A joint Structural Engineers Association of Southern California (SEAOSC) and both the Los Angeles County and Los Angeles City Task Force investigated the performance of hillside building failures after the Northridge earthquake. Numerous hillside failures resulted in loss of life and millions of dollars in damage. These criteria were developed to minimize the damage to these structures and have been in use by both the City and County of Los Angeles for several years with much success. This proposed amendment is a continuation of an amendment adopted during previous code adoption cycles.

FINDINGS:

Local Topographical and Geological Conditions – The greater Los Angeles region is a densely populated area having buildings and structures constructed over and near a vast array of fault systems capable of producing major earthquakes, including but not limited to the recent 1994 Northridge Earthquake. Additionally, the topography within the Los Angeles region includes significant hillsides with narrow and winding access that makes timely response by fire suppression vehicles challenging and difficult. The proposed modification establishes design parameters to better mitigate and limit property damage that are the results of increased seismic forces which are imparted upon hillside buildings and structures and therefore need to be incorporated into the code to assure that new buildings and structures and additions or alterations to existing buildings or structures are designed and constructed in accordance with the scope and objectives of the International Building Code.

2010 LARUCP 16-8. Section 1613.13 is added to Chapter 16 of the 2010 Edition of the California Building Code to read as follows:

1613.13 Suspended Ceilings. Minimum design and installation standards for suspended ceilings shall be determined in accordance with the requirements of Section 2506.2.1 of this Code and this subsection.

1613.13.1 Scope. This part contains special requirements for suspended ceilings and lighting systems. Provisions of Section 13.5.6 of ASCE 7 shall apply except as modified herein.

1613.13.2 General. The suspended ceilings and lighting systems shall be limited to 6 feet (1828 mm) below the structural deck unless the lateral bracing is designed by a licensed engineer or architect.

1613.13.3 Design and Installation Requirements.

1613.13.3.1 Bracing at Discontinuity. Positive bracing to the structure shall be provided at changes in the ceiling plane elevation or at discontinuities in the ceiling grid system.

1613.13.3.2 Support for Appendages. Cable trays, electrical conduits and piping shall be independently supported and independently braced from the structure.

1613.13.3.3 Sprinkler Heads. All sprinkler heads (drops) except fire-resistance-rated floor/ceiling or roof/ceiling assemblies, shall be designed to allow for free movement of the sprinkler pipes with oversize rings, sleeves or adaptors through the ceiling tile, in accordance with Section 13.5.6.2.2 (e) of ASCE 7.

Sprinkler heads penetrating fire-resistance-rated floor/ceiling or roof/ceiling assemblies shall comply with Section 713 of this Code.

1613.13.3.4 Perimeter Members. A minimum wall angle size of at least a two-inch (51 mm) horizontal leg shall be used at perimeter walls and interior full height partitions. The first ceiling tile shall maintain 3/4 inch (19 mm) clear from the finish wall surface. An equivalent alternative detail that will provide sufficient movement due to anticipated lateral building displacement may be used in lieu of the long leg angle subject to the approval of the Superintendent of Building.

1613.13.4 Special Requirements for Means of Egress. Suspended ceiling assemblies located along means of egress serving an occupant load of 30 or more shall comply with the following provisions.

1613.13.4.1 General. Ceiling suspension systems shall be connected and braced with vertical hangers attached directly to the structural deck along the means of egress serving an occupant load of 30 or more and at lobbies accessory to Group A Occupancies. Spacing of vertical hangers shall not exceed 2 feet (610 mm) on center along the entire length of the suspended ceiling assembly located along the means of egress or at the lobby.

1613.13.4.2 Assembly Device. All lay-in panels shall be secured to the suspension ceiling assembly with two hold-down clips minimum for each tile within a 4-foot (1219 mm) radius of the exit lights and exit signs.

1613.13.4.3 Emergency Systems. Independent supports and braces shall be provided for light fixtures required for exit illumination. Power supply for exit illumination shall comply with the requirements of Section 1006.3 of this Code.

1613.13.4.4 Supports for Appendage. Separate support from the structural deck shall be provided for all appendages such as light fixtures, air diffusers, exit signs, and similar elements.

RATIONALE:

The California Building Code has little to no information regarding the safe design and construction requirements for ceiling suspension systems subject to seismic loads. It is through the experience of prior earthquakes, such as the Northridge Earthquake, that this amendment is proposed so as to minimize the amount of bodily and building damage within the spaces in which this type of ceiling will be installed. This proposed amendment is a continuation of an amendment adopted during previous code adoption cycles.

FINDINGS:

Local Geological Conditions – The greater Los Angeles/Long Beach region is a densely populated area having buildings constructed over and near a vast array of fault systems capable of producing major earthquakes, including but not limited to the recent 1994 Northridge Earthquake. The proposed modification requiring safe design and construction requirements for ceiling suspension systems to resist seismic loads is intended to minimize the amount of damage within a building and therefore need to be incorporated into the code to assure that new buildings and additions to existing buildings are designed and constructed in accordance with the scope and objectives of the International Building Code.

2010 LARUCP 17-01. Section 1704.4 of the 2010 Edition of the California Building Code is amended to read as follows:

1704.4 Concrete Construction. The special inspections and verifications for concrete construction shall be as required by this section and Table 1704.4.

Exceptions: Special inspection shall not be required for:

1. Isolated spread concrete footings of buildings three stories or less above grade plane that are fully supported on earth or rock, where the structural design of the footing is based on a specified compressive strength, f'c, no greater than 2,500 pounds per square inch (psi) (17.2 Mpa).
2. Continuous concrete footings supporting walls of buildings three stories or less in height that are fully supported on earth or rock where:
 - 2.1. The footings support walls of light-frame construction;
 - 2.2. The footings are designed in accordance with Table 1805.4.2; or
 - 2.3. The structural design of the footing is based on a specified compressive strength, f'c, no greater than 2,500 pounds per square inch (psi) (17.2 Mpa), regardless of the compressive strength specified in the construction documents or used in the footing construction.
3. Nonstructural concrete slabs supported directly on the ground, including prestressed slabs on grade, where the effective prestress in the concrete is less than 150 psi (1.03 Mpa).
- ~~4. Concrete foundation walls constructed in accordance with Table 1807.1.6.2.~~
- ~~5. Concrete patios, driveways and sidewalks, on grade.~~

RATIONALE:

Results from studies after the 1994 Northridge Earthquake indicated that a lot of the damages were attributed to lack of quality control during construction resulting in poor performance of the building or structure. Therefore, the proposed amendment requires special inspection for concrete with a compressive strength greater than 2,500 pounds per square inch. This proposed amendment is a continuation of an amendment adopted during previous code adoption cycles.

FINDINGS:

Local Geological Conditions – The greater Los Angeles region is a densely populated area having buildings and structures constructed over and near a vast array of fault systems capable of producing major earthquakes, including but not limited to the recent 1994 Northridge Earthquake. The proposed modification to require special inspection for concrete with a compressive strength greater than 2,500 psi to improve quality of control during construction and therefore need to be incorporated into the code to assure that new buildings and structures and additions or alterations to existing buildings or structures are designed and constructed in accordance with the scope and objectives of the International Building Code.

2010 LARUCP 17-02. Section 1704.8 of the 2010 Edition of the California Building Code is amended to read as follows:

1704.8 Driven deep foundations and connection grade beams. Special inspections shall be performed during installation and testing of driven deep foundation elements as required by Table 1704.8. Special inspections shall be performed for connection grade beams in accordance with Section 1704.4 for structures assigned to Seismic Design Category D, E or F. The approved geotechnical report, and the construction documents prepared by the registered design professionals, shall be used to determine compliance.

RATIONALE:

Studies after the Northridge Earthquake revealed that great confusion exist in the field over what is required by the code in the way of special inspection beyond just piles and caissons. Connecting grade beams used in driven deep foundations will generally act like concrete beams and should not be treated like typical footings. Section 1704.4 requires concrete beams to have special inspection, but exempts the footings of buildings three stories or less in height. This amendment clarifies that the grade beams that connect driven deep foundations are not exempt from special inspection even if they are used as part of the foundation system. They are an essential part of the driven deep foundation system and should receive the same level of inspection, particularly since this type of system must resist the higher seismic demand loads in this region.

FINDINGS:

Local Geological Conditions – The greater Los Angeles region is a densely populated area having buildings and structures constructed over and near a vast array of fault systems capable of producing major earthquakes, including but not limited to the recent 1994 Northridge Earthquake. The proposed modification to require special inspection of connecting grade beams to ensure adequate performance of the foundation system and therefore need to be incorporated into the code to assure that new buildings and structures and additions or alterations to existing buildings or structures are designed and constructed in accordance with the scope and objectives of the International Building Code.

2010 LARUCP 17-03. Section 1704.9 of the 2010 Edition of the California Building Code is amended to read as follows:

1704.9 Cast-in-place deep foundations and connection grade beams. Special inspections shall be performed during installation and testing of cast-in-place deep foundation elements as required by Table 1704.9. Special inspections shall be performed for connection grade beams in accordance with Section 1704.4 for structures assigned to Seismic Design Category D, E or F. The approved geotechnical report, and the construction documents prepared by the registered design professionals, shall be used to determine compliance.

RATIONALE:

Studies after the Northridge Earthquake revealed that great confusion exist in the field over what is required by the code in the way of special inspection beyond just piles and caissons. Connecting grade beams used in cast-in-place deep foundations will generally act like concrete beams and should not be treated like typical footings. Section 1704.4 requires concrete beams to have special inspection, but exempts the footings of buildings three stories or less in height. This amendment clarifies that the grade beams that connect cast-in-place deep foundations are not exempt from special inspection even if they are used as part of the foundation system. They are an essential part of the cast-in-place deep foundation system and should receive the same level of inspection, particularly since this type of system must resist the higher seismic demand loads in this region.

FINDINGS:

Local Geological Conditions – The greater Los Angeles region is a densely populated area having buildings and structures constructed over and near a vast array of fault systems capable of producing major earthquakes, including but not limited to the recent 1994 Northridge Earthquake. The proposed modification to require special inspection of connecting grade beams to ensure adequate performance of the foundation system and therefore need to be incorporated into the code to assure that new buildings and structures and additions or alterations to existing buildings or structures are designed and constructed in accordance with the scope and objectives of the International Building Code.

2010 LARUCP 17-04. Section 1705.3 of the 2010 Edition of the California Building Code is amended to read as follows:

1705.3 Seismic resistance. The statement of special inspections shall include seismic requirements for cases covered in Sections 1705.3.1 through 1705.3.5.

Exception: Seismic requirements are permitted to be excluded from the statement of special inspections for structures designed and constructed in accordance with the following:

1. The structure consists of light-frame construction; the design spectral response acceleration at short periods, S_{DS} , as determined in Section 1613.5.4, does not exceed 0.5g; and the height of the structure does not exceed 35 feet (10 668 mm) above grade plane; or
2. The structure is constructed using a reinforced masonry structural system or reinforced concrete structural system; the design spectral response acceleration at short periods, S_{DS} , as determined in Section 1613.5.4, does not exceed 0.5g, and the height of the structure does not exceed 25 feet (7620 mm) above grade plane; or
3. Detached one- or two-family dwellings not exceeding two stories above grade plane, provided the structure is not assigned to Seismic Design Category D, E or F and does not have any of the following plan or vertical irregularities in accordance with Section 12.3.2 of ASCE 7:
 - 3.1 Torsional irregularity.
 - 3.2 Nonparallel systems.
 - 3.3 Stiffness irregularity—extreme soft story and soft story.
 - 3.4 Discontinuity in capacity—weak story.

RATIONALE:

In southern California, very few detached one- or two-family dwellings not exceeding two stories above grade plane are built as “box-type” structures, specially for those in hillside areas and near the oceanfront. Many steel moment frames or braced frames and/or cantilevered columns within buildings can still be shown as “regular” structures by calculations. With the higher seismic demand placed on buildings and structures in this region, the language in Sections 1705.3 Item 3 of the California Building Code would permit many detached one- or two-family dwellings not exceeding two stories above grade plane with complex structural elements to be constructed without the benefit of special inspections. By requiring special inspections, the quality of major structural elements and connections that affect the vertical and lateral load resisting systems of the structure will greatly be increased. The exception should only be allowed for detached one- or two-family dwellings not exceeding two stories above grade plane assigned to Seismic Design category A, B and C.

FINDINGS:

Local Geological Conditions – The greater Los Angeles region is a densely populated area having buildings and structures constructed over and near a vast array of fault systems capable of producing major earthquakes, including but not limited to the recent 1994 Northridge Earthquake. The proposed modification to require special inspections for detached one- or two-family dwellings not exceeding two stories above grade plane assigned to Seismic Design Category D, E and F will help ensure that acceptable standards of workmanship and quality of construction are provided and therefore needs to be incorporated into the code to assure that new buildings and structures and additions or alterations to existing buildings or structures are designed and constructed in accordance with the scope and objectives of the International Building Code.

FY 2010 LOS ANGELES REGION UNIFORM CODE PROGRAM (LARUCP)

2010 LARUCP 17-05. Section 1710.1 of the 2010 Edition of the California Building Code is amended to read as follows:

1710.1 General. Where required by the provisions of Section 1710.2 or 1710.3, the owner shall employ a ~~registered design professional~~ structural observer to perform structural observations as defined in Section 1702. The structural observer shall be one of the following individuals:

1. The registered design professional responsible for the structural design, or
2. A registered design professional designated by the registered design professional responsible for the structural design.

Prior to the commencement of observations, the structural observer shall submit to the building official a written statement identifying the frequency and extent of structural observations.

~~At the conclusion of the work included in the permit, the structural observer shall submit to the building official a written statement that the site visits have been made and identify any reported deficiencies that, to the best of the structural observer's knowledge, have not been resolved.~~

The owner or owner's representative shall coordinate and call a preconstruction meeting between the structural observer, contractors, affected subcontractors and special inspectors. The structural observer shall preside over the meeting. The purpose of the meeting shall be to identify the major structural elements and connections that affect the vertical and lateral load resisting systems of the structure and to review scheduling of the required observations. A record of the meeting shall be included in the report submitted to the building official.

Observed deficiencies shall be reported in writing to the owner or owner's representative, special inspector, contractor and the building official. Upon the form prescribed by the building official, the structural observer shall submit to the building official a written statement at each significant construction stage stating that the site visits have been made and identifying any reported deficiencies which, to the best of the structural observer's knowledge, have not been resolved. A final report by the structural observer which states that all observed deficiencies have been resolved is required before acceptance of the work by the building official.

RATIONALE:

The language in Section 1710.1 of the California Building Code permits the owner to employ any registered design professional to perform structural observations with minimum guideline. However, it is important to recognize that the registered design professional responsible for the structural design has thorough knowledge of the building he/she designed. By requiring the registered design professional responsible for the structural design or their designee who were involved with the design to observe the construction, the quality of the observation for major structural elements and connections that affect the vertical and lateral load resisting systems of the structure will greatly be increased. Additional requirements are provided to help clarify the role and duties of the structural observer and the method of reporting and correcting observed deficiencies to the building official. This proposed amendment is a continuation of an amendment adopted during previous code adoption cycles.

FINDINGS:

Local Geological Conditions – The greater Los Angeles region is a densely populated area having buildings and structures constructed over and near a vast array of fault systems capable of producing major earthquakes, including but not limited to the recent 1994 Northridge Earthquake. The proposed modification to require the registered design professional in responsible charge for the structural design to observe the construction will help ensure acceptable standards of workmanship is provided and to

improve the quality of the observation and therefore need to be incorporated into the code to assure that new buildings and structures and additions or alterations to existing buildings or structures are designed and constructed in accordance with the scope and objectives of the International Building Code.

2010 LARUCP 17-06. Section 1710.2 of the 2010 Edition of the California Building Code is amended to read as follows:

1710.2 Structural observations for seismic resistance. Structural observations shall be provided for those structures assigned to Seismic Design Category D, E or F, as determined in Section 1613, where one or more of the following conditions exist:

1. The structure is classified as Occupancy Category III or IV in accordance with Table 1604.5.
2. The height of the structure is greater than 75 feet (22860 mm) above the base.
3. The structure ~~is assigned to Seismic Design Category E,~~ is classified as Occupancy Category I or II in accordance with Table 1604.5, and ~~is greater than two stories one stories above grade plane~~ a lateral design is required for the structure or portion thereof.

Exception: One-story wood framed Group R-3 and Group U Occupancies less than 2,000 square feet in area, provided the adjacent grade is not steeper than 1 unit vertical in 10 units horizontal (10% sloped), assigned to Seismic Design Category D.

4. When so designated by the registered design professional responsible for the structural design.
5. When such observation is specifically required by the building official.

RATIONALE:

With the higher seismic demand placed on buildings and structures in this region, the language in Section 1710.2 Item 3 of the California Building Code would permit many low-rise buildings and structures with complex structural elements to be constructed without the benefit of a structural observation. By requiring a registered design professional to observe the construction, the quality of the observation for major structural elements and connections that affect the vertical and lateral load resisting systems of the structure will greatly be increased. An exception is provided to permit simple structures and buildings to be excluded. This proposed amendment is a continuation of an amendment adopted during previous code adoption cycles.

FINDINGS:

Local Geological Conditions – The greater Los Angeles region is a densely populated area having buildings and structures constructed over and near a vast array of fault systems capable of producing major earthquakes, including but not limited to the recent 1994 Northridge Earthquake. The proposed modification to require the registered design professional in responsible charge for the structural design to observe the construction will help ensure acceptable standards of workmanship is provided and to improve the quality of the observation and therefore need to be incorporated into the code to assure that new buildings and structures and additions or alterations to existing buildings or structures are designed and constructed in accordance with the scope and objectives of the International Building Code.

2010 LARUCP 18-01. Section 1807.1.4 of the 2010 Edition of the California Building Code is amended to read as follows:

1807.1.4 Permanent wood foundation systems. Permanent wood foundation systems shall be designed and installed in accordance with AF&PA PWF. Lumber and plywood shall be treated in accordance with AWWA U1 (Commodity Specification A, Use Category 4B and Section 5.2) and shall be identified in accordance with Section 2303.1.8.1. Permanent wood foundation systems shall not be used for structures assigned to Seismic Design Category D, E or F.

RATIONALE:

No substantiating data has been provided to show that wood foundation is effective in supporting buildings and structures during a seismic event while being subject to deterioration caused by the combined detrimental effect of constant moisture in the soil and wood-destroying organisms. Wood foundation systems, when they are not properly treated and protected against deterioration, have performed very poorly and have led to slope failures. Most contractors are typically accustomed to construction in dry and temperate weather in the Southern California region and are not generally familiar with the necessary precautions and treatment of wood that makes it suitable for both seismic event and wet applications. The proposed amendment takes the precautionary steps to reduce or eliminate potential problems that may result in using wood foundation systems that experience relatively rapid decay due to the fact that the region does not experience temperatures cold enough to destroy or retard the growth and proliferation of wood-destroying organisms. This proposed amendment is a continuation of an amendment adopted during previous code adoption cycles.

FINDINGS:

Local Climatic and Geological Conditions – The greater Los Angeles region is a densely populated area having buildings and structures constructed over and near a vast array of fault systems capable of producing major earthquakes, including but not limited to the recent 1994 Northridge Earthquake. In addition, the region is within a climate system capable of producing major winds, fire and rain related disasters, including but not limited to those caused by the Santa Ana winds and El Nino (or La Nina) subtropical-like weather. This region is especially susceptible to more active termite and wood attacking insects and microorganisms. The proposed modification to prohibit the use of wood foundation systems as well as limit prescriptive design provisions in an effort to mitigate potential problems or deficiencies due to the proliferation of wood-destroying organisms and therefore need to be incorporated into the code to assure that new buildings and structures and additions or alterations to existing buildings or structures are designed and constructed in accordance with the scope and objectives of the International Building Code.

2010 LARUCP 18-02. Section 1807.1.6 of the 2010 Edition of the California Building Code is amended to read as follows:

1807.1.6 Prescriptive design of concrete and masonry foundation walls. Concrete and masonry foundation walls that are laterally supported at the top and bottom shall be permitted to be designed and constructed in accordance with this section. Prescriptive design of foundation walls shall not be used for structures assigned to Seismic Design Category D, E or F.

RATIONALE:

With the higher seismic demand placed on buildings and structures in this region, it is deemed necessary to take precautionary steps to reduce or eliminate potential problems that may result by following prescriptive design provisions that does not take into consideration the surrounding environment. Plain concrete performs poorly in withstanding the cyclic forces resulting from seismic events. In addition, no substantiating data has been provided to show that under-reinforced foundation walls are effective in resisting seismic loads and may potentially lead to a higher risk of failure. It is important that the benefit and expertise of a registered design professional be obtained to properly analyze the structure and take these issues into consideration. This proposed amendment is a continuation of an amendment adopted during previous code adoption cycles.

FINDINGS:

Local Geological Conditions – The greater Los Angeles region is a densely populated area having buildings and structures constructed over and near a vast array of fault systems capable of producing major earthquakes, including but not limited to the recent 1994 Northridge Earthquake. The proposed modification to prohibit prescriptive design provisions for foundation walls as plain concrete have performed poorly in withstanding the cyclic forces resulting from seismic events and to require the walls to be designed by a registered design professional to ensure that the proper analysis of the structure takes into account the surrounding condition and therefore need to be incorporated into the code to assure that new buildings and structures and additions or alterations to existing buildings or structures are designed and constructed in accordance with the scope and objectives of the International Building Code.

2010 LARUCP 18-03. Section 1809.3 of the 2010 Edition of the California Building Code is amended to read as follows:

1809.3 Stepped footings. The top surface of footings shall be level. The bottom surface of footings shall be permitted to have a slope not exceeding one unit vertical in 10 units horizontal (10-percent slope). Footings shall be stepped where it is necessary to change the elevation of the top surface of the footing or where the surface of the ground slopes more than one unit vertical in 10 units horizontal (10-percent slope).

For structures assigned to Seismic Design Category D, E or F, the stepping requirement shall also apply to the top surface of grade beams supporting walls. Footings shall be reinforced with four 1/2-inch diameter (12.7 mm) deformed reinforcing bars. Two bars shall be placed at the top and bottom of the footings as shown in Figure 1809.3.

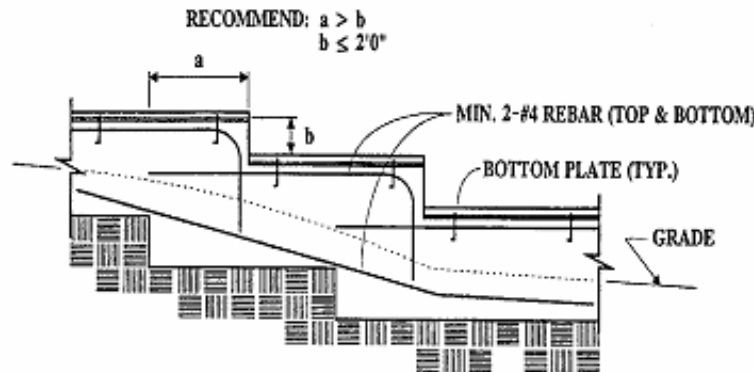

STEPPED FOUNDATIONS

FIGURE 1809.3
STEPPED FOOTING

RATIONALE:

With the higher seismic demand placed on buildings and structures in this region, precautionary steps are proposed to reduce or eliminate potential problems that may result for under reinforced footings located on sloped surfaces. Requiring minimum reinforcement for stepped footings is intended to address the problem of poor performance of plain or under-reinforced footings during a seismic event. This proposed amendment is a continuation of an amendment adopted during previous code adoption cycles.

FINDINGS:

Local Geological Conditions – The greater Los Angeles region is a densely populated area having buildings and structures constructed over and near a vast array of fault systems capable of producing major earthquakes, including but not limited to the recent 1994 Northridge Earthquake. The proposed modification to require minimum reinforcement in stepped footings is intended to improve performance of buildings and structures and therefore need to be incorporated into the code to assure that new buildings and structures and additions or alterations to existing buildings or structures are designed and constructed in accordance with the scope and objectives of the International Building Code.

2010 LARUCP 18-04. Section 1809.7 and Table 1809.7 of the 2010 Edition of the California Building Code are amended to read as follows:

1809.7 Prescriptive footings for light-frame construction. Where a specific design is not provided, concrete or masonry-unit footings supporting walls of light-frame construction shall be permitted to be designed in accordance with Table 1809.7. Prescriptive footings in Table 1809.7 shall not exceed one story above grade plane for structures assigned to Seismic Design Category D, E or F.

**TABLE 1809.7
PRESCRIPTIVE FOOTINGS SUPPORTING WALLS OF
LIGHT-FRAME CONSTRUCTION** ^{a, b, c, d, e}

NUMBER OF FLOORS SUPPORTED BY THE FOOTING ^f	WIDTH OF FOOTING (inches)	THICKNESS OF FOOTING (inches)
1	12	6
2	15	6
3	18	8 ^g

For SI: 1 inch = 25.4 mm, 1 foot = 304.8 mm

- a. Depth of footings shall be in accordance with Section 1809.4.
- b. The ground under the floor shall be permitted to be excavated to the elevation of the top of the footing.
- c. ~~Interior stud-bearing walls shall be permitted to be supported by isolated footings. The footing width and length shall be twice the width shown in this table, and footings shall be spaced not more than 6 feet on center. Not Adopted.~~
- d. See Section 1908 for additional requirements for concrete footings of structures assigned to Seismic Design Category C, D, E or F.
- e. For thickness of foundation walls, see Section 1807.1.6.
- f. Footings shall be permitted to support a roof addition to the stipulated number of floors. Footings supporting roof only shall be as required for supporting one floor.
- g. ~~Plain concrete footings for Group R-3 occupancies shall be permitted to be 6 inches thick.~~

RATIONALE:

No substantiating data has been provided to show that under-reinforced footings are effective in resisting seismic loads and may potentially lead to a higher risk of failure. Therefore, this proposed amendment requires minimum reinforcement in continuous footings to address the problem of poor performance of plain or under-reinforced footings during a seismic event. With the higher seismic demand placed on buildings and structures in this region, precautionary steps are proposed to reduce or eliminate potential problems that may result by following prescriptive design provisions for footing that does not take into consideration the surrounding environment. It was important that the benefit and expertise of a registered design professional be obtained to properly analysis the structure and takes these issues into consideration. This amendment reflects the recommendations by the Structural Engineers Association of Southern California (SEAOSC) and the Los Angeles City Task Force that investigated the poor performance observed in 1994 Northridge Earthquake. This proposed amendment is a continuation of an amendment adopted during previous code adoption cycles.

FINDINGS:

Local Geological Conditions – The greater Los Angeles region is a densely populated area having buildings and structures constructed over and near a vast array of fault systems capable of producing major earthquakes, including but not limited to the recent 1994 Northridge Earthquake. The proposed modification to limit the use of the prescriptive design provisions and under-reinforced or plain concrete is to ensure that the proper analysis of the structure takes into account the surrounding condition and therefore need to be incorporated into the code to assure that new buildings and structures and additions or alterations to existing buildings or structures are designed and constructed in accordance with the scope and objectives of the International Building Code.

2010 LARUCP 18-05. Section 1809.12 of the 2010 Edition of the California Building Code is amended to read as follows:

1809.12 Timber footings. Timber footings shall be permitted for buildings of Type V construction and as otherwise approved by the building official. Such footings shall be treated in accordance with AWWPA U1 (Commodity Specification A, Use Category 4B). Treated timbers are not required where placed entirely below permanent water level, or where used as capping for wood piles that project above the water level over submerged or marsh lands. The compressive stresses perpendicular to grain in untreated timber footing supported upon treated piles shall not exceed 70 percent of the allowable stresses for the species and grade of timber as specified in the AF&PA NDS. Timber footings shall not be used in structures assigned to Seismic Design Category D, E or F.

RATIONALE:

No substantiating data has been provided to show that timber footings is effective in supporting buildings and structures during a seismic event while being subject to deterioration caused by the combined detrimental effect of constant moisture in the soil and wood-destroying organisms. Timber footings, when they are not properly treated and protected against deterioration, have performed very poorly. Most contractors are typically accustomed to construction in dry and temperate weather in the Southern California region and are not generally familiar with the necessary precautions and treatment of wood that makes it suitable for both seismic event and wet applications. The proposed amendment takes the precautionary steps to reduce or eliminate potential problems that may result by using timber footings that experience relatively rapid decay due to the fact that the region does not experience temperatures cold enough to destroy or retard the growth and proliferation of wood-destroying organisms. This proposed amendment is a continuation of an amendment adopted during previous code adoption cycles.

FINDINGS:

Local Climatic and Geological Conditions – The greater Los Angeles region is a densely populated area having buildings and structures constructed over and near a vast array of fault systems capable of producing major earthquakes, including but not limited to the recent 1994 Northridge Earthquake. In addition, the region is within a climate system capable of producing major winds, fire and rain related disasters, including but not limited to those caused by the Santa Ana winds and El Nino (or La Nina) subtropical-like weather. This region is especially susceptible to more active termite and wood attacking insects and microorganisms. The proposed modification to prohibit the use of timber footings in an effort to mitigate potential problems or deficiencies due to the proliferation of wood-destroying organisms and therefore need to be incorporated into the code to assure that new buildings and structures and additions or alterations to existing buildings or structures are designed and constructed in accordance with the scope and objectives of the International Building Code.

2010 LARUCP 18-06. Section 1810.3.2.4 of the 2010 Edition of the California Building Code is amended to read as follows:

1810.3.2.4 Timber. Timber deep foundation elements shall be designed as piles or poles in accordance with AF&PA NDS. Round timber elements shall conform to ASTM D 25. Sawn timber elements shall conform to DOC PS-20. Timber shall not be used in structures assigned to Seismic Design Category D, E or F.

RATIONALE:

No substantiating data has been provided to show that timber deep foundation is effective in supporting buildings and structures during a seismic event while being subject to deterioration caused by the combined detrimental effect of constant moisture in the soil and wood-destroying organisms. Timber deep foundation, when they are not properly treated and protected against deterioration, has performed very poorly. Most contractors are typically accustomed to construction in dry and temperate weather in the Southern California region and are not generally familiar with the necessary precautions and treatment of wood that makes it suitable for both seismic event and wet applications. The proposed amendment takes the precautionary steps to reduce or eliminate potential problems that may result by using timber deep foundation that experience relatively rapid decay due to the fact that the region does not experience temperatures cold enough to destroy or retard the growth and proliferation of wood-destroying organisms. This proposed amendment is a continuation of an amendment adopted during previous code adoption cycles.

FINDINGS:

Local Climatic and Geological Conditions – The greater Los Angeles region is a densely populated area having buildings and structures constructed over and near a vast array of fault systems capable of producing major earthquakes, including but not limited to the recent 1994 Northridge Earthquake. In addition, the region is within a climate system capable of producing major winds, fire and rain related disasters, including but not limited to those caused by the Santa Ana winds and El Nino (or La Nina) subtropical-like weather. This region is especially susceptible to more active termite and wood attacking insects and microorganisms. The proposed modification to prohibit the use of timber deep foundation in an effort to mitigate potential problems or deficiencies due to the proliferation of wood-destroying organisms and therefore need to be incorporated into the code to assure that new buildings and structures and additions or alterations to existing buildings or structures are designed and constructed in accordance with the scope and objectives of the International Building Code.

FY 2010 LOS ANGELES REGION UNIFORM CODE PROGRAM (LARUCP)

2010 LARUCP 19-01. Section 1908.1 is amended to read as shown below and Sections 1908.1.11 thru 1908.1.14 is added to Chapter 19 of the 2010 Edition of the California Building Code to read as follows:

1908.1 General. The text of ACI 318 shall be modified as indicated in Sections 1908.1.1 through 1908.1.14.

1908.1.11 ACI 318, Section 21.6.4.1. Modify ACI 318, Section 21.6.4.1, to read as follows:

Where the calculated point of contraflexure is not within the middle half of the member clear height, provide transverse reinforcement as specified in ACI 318 Sections 21.6.4.1, Items (a) through (c), over the full height of the member.

1908.1.12 ACI 318, Section 21.6.4. Modify ACI 318, Section 21.6.4, by adding Section 21.6.4.8 to read as follows:

21.6.4.8 – At any section where the design strength, ϕP_n , of the column is less than the sum of the shears V_e computed in accordance with ACI 318 Sections 21.5.4.1 and 21.6.5.1 for all the beams framing into the column above the level under consideration, transverse reinforcement as specified in ACI 318 Sections 21.6.4.1 through 21.6.4.3 shall be provided. For beams framing into opposite sides of the column, the moment components may be assumed to be of opposite sign. For the determination of the design strength, ϕP_n , of the column, these moments may be assumed to result from the deformation of the frame in any one principal axis.

1908.1.13 ACI 318, Section 21.9.4. Modify ACI 318, Section 21.9.4, by adding Section 21.9.4.6 to read as follows:

21.9.4.6 – Walls and portions of walls with $P_u > 0.35P_o$ shall not be considered to contribute to the calculated strength of the structure for resisting earthquake-induced forces. Such walls shall conform to the requirements of ACI 318 Section 21.13.

1908.1.14 ACI 318, Section 21.11.6. Modify ACI 318, Section 21.11.6, by adding the following:

Collector and boundary elements in topping slabs placed over precast floor and roof elements shall not be less than 3 inches (76 mm) or $6 d_b$ thick, where d_b is the diameter of the largest reinforcement in the topping slab.

RATIONALE:

This amendment is intended to carry over critical provisions for the design of concrete columns in moment frames from the UBC. Increased confinement is critical to the integrity of such columns and these modifications ensure that it is provided when certain thresholds are exceeded.

In addition, this amendment carries over from the UBC a critical provision for the design of concrete shear walls. It essentially limits the use of very highly gravity-loaded walls in being included in the seismic load resisting system, since their failure could have catastrophic effect on the building.

Furthermore, this amendment was incorporated in the code based on observations from the 1994 Northridge Earthquake. Rebar placed in very thin concrete topping slabs have been observed in some instances to have popped out of the slab due to insufficient concrete coverage. This modification ensures that critical boundary and collector rebars are placed in sufficiently thick slab to prevent buckling of such reinforcements.

This proposed amendment is a continuation of amendment 19-02 (2007) adopted during previous code adoption cycle with editorial revisions of ACI section numbering.

FINDINGS:

Local Geological Conditions – The greater Los Angeles region is a densely populated area having buildings and structures constructed over and near a vast array of fault systems capable of producing major earthquakes, including but not limited to the recent 1994 Northridge Earthquake. The proposed modification to increase confinement in critical columns, limiting the use of highly gravity loaded walls, and increase concrete coverage in thin slabs will have to prevent failure of the structure and therefore need to be incorporated into the code to assure that new buildings and structures and additions or alterations to existing buildings or structures are designed and constructed in accordance with the scope and objectives of the International Building Code.

2010 LARUCP 19-02. Section 1908.1.2 of the 2010 Edition of the California Building Code is amended to read as follows:

1908.1.2 ACI 318, Section 21.1.1. Modify ACI 318, Sections 21.1.1.3 and 21.1.1.7 as follows:

21.1.1.3 – Structures assigned to Seismic Design Category A shall satisfy requirements of Chapters 1 to 19 and 22; Chapter 21 does not apply. Structures assigned to Seismic Design Category B, C, D, E or F also shall satisfy 21.1.1.4 through 21.1.1.8, as applicable. Except for structural elements of plain concrete complying with Section 1908.1.8 of the International Building Code, structural elements of plain concrete are prohibited in structures assigned to Seismic Design Category C, D, E or F.

21.1.1.7 – Structural systems designated as part of the seismic-force-resisting system shall be restricted to those permitted by ASCE 7. Except for Seismic Design Category A, for which Chapter 21 does not apply, the following provisions shall be satisfied for each structural system designated as part of the seismic-force-resisting system, regardless of the Seismic Design Category:

- (a) Ordinary moment frames shall satisfy 21.2.
- (b) Ordinary reinforced concrete structural walls and ordinary precast structural walls need not satisfy any provisions in Chapter 21.
- (c) Intermediate moment frames shall satisfy 21.3.
- (d) Intermediate precast structural walls shall satisfy 21.4.
- (e) Special moment frames shall satisfy 21.5 through 21.8.
- (f) Special structural walls shall satisfy 21.9.
- (g) Special structural walls constructed using precast concrete shall satisfy 21.10.

All special moment frames and special structural walls shall also satisfy 21.1.3 through 21.1.7. Concrete tilt-up wall panels classified as intermediate precast structural wall system shall satisfy 21.9 in addition to 21.4.2 and 21.4.3 for structures assigned to Seismic Design Category D, E or F.

RATIONALE:

By virtue of ACI 318 Section 21.1.1.7(d), intermediate precast structural walls designed under Section 21.4, material requirements intended under provisions 21.1.4, 21.1.5, 21.1.6, and 21.1.7 would be excluded for structures assigned to Seismic Design Category D, E or F. Clarification of ACI 318 Chapter 21 is needed to ensure that structural walls designed under ASCE 7 Table 12.2-1 using the intermediate wall panel category would conform to ductility requirements comparable to special structural wall; and conformance to the long standing practice of ACI 318 to impose special requirements for high seismic design regions. This amendment gives explicit requirement under which design and detailing need to conform to special structural wall system provision in ACI-318 Section 21.9, which covers both cast-in-place as well as precast. This amendment further gives building officials the tools to enforce minimum life safety building performance under earthquake forces in Seismic Design Category D, E or F.

FINDINGS:

Local Geological Conditions – The greater Los Angeles region is a densely populated area having buildings and structures constructed over and near a vast array of fault systems capable of producing major earthquakes, including but not limited to the recent 1994 Northridge Earthquake. The proposed modification to intermediate structural wall system is intended to assure that ductility requirements for high seismic region is provided and therefore needs to be incorporated into the code to assure that new buildings and structures and additions or alterations to existing buildings or structures are designed and constructed in accordance with the scope and objectives of the International Building Code and ACI 318.

FY 2010 LOS ANGELES REGION UNIFORM CODE PROGRAM (LARUCP)

2010 LARUCP 19-03. Section 1908.1.3 of the 2010 Edition of the California Building Code is amended to read as follows:

1908.1.3 ACI 318, Section 21.4. Modify ACI 318, Section 21.4, by renumbering Section 21.4.3 to become 21.4.4 and adding new Sections 21.4.3, 21.4.5, ~~and~~ 21.4.6 and 21.4.7 to read as follows:

21.4.3 – Connections that are designed to yield shall be capable of maintaining 80 percent of their design strength at the deformation induced by the design displacement or shall use Type 2 mechanical splices.

21.4.4 – Elements of the connection that are not designed to yield shall develop at least $1.5 S_y$.

21.4.5 – Wall piers in Seismic Design Category D, E or F shall comply with Section 1908.1.4 of this Code.

~~21.4.5~~21.4.6 – Wall piers not designed as part of a moment frame in buildings assigned to Seismic Design Category C shall have transverse reinforcement designed to resist the shear forces determined from 21.3.3. Spacing of transverse reinforcement shall not exceed 8 inches (203 mm). Transverse reinforcement shall be extended beyond the pier clear height for at least 12 inches (305 mm).

Exceptions:

1. Wall piers that satisfy 21.13.
2. Wall piers along a wall line within a story where other shear wall segments provide lateral support to the wall piers and such segments have a total stiffness of at least six times the sum of the stiffnesses of all the wall piers.

~~21.4.6~~21.4.7 – Wall segments with a horizontal length-to-thickness ratio less than 2.5 shall be designed as columns.

RATIONALE:

The design provision for wall pier detailing was originally introduced by SEAOC in 1987 to legacy Uniform Building Code (UBC) and was included in the 1988 UBC through the 1997 UBC (2002 CBC). The wall pier detailing provision prescribed under Section 1908.1.4 was intended for high seismic zones equivalent to current Seismic Design Category D, E or F. Section 1908.1.3 was added as a complement of wall pier detailing in Seismic Design Category C (formerly seismic zones 2A and 2B under the legacy model code). ACI 318 Commentary R 21.1.1 emphasized “it is essential that structures assigned to higher Seismic Design Categories possess a higher degree of toughness”, and further encourages practitioners to use special structural wall system in regions of high seismic risk. ASCE 7 Table 12.2-1 permits intermediate precast structural wall system in Seismic Design Category D, E or F. Current Section 1908.1.3 does not limit to just structures assigned to Seismic Design Category C. The required shear strength under 21.3.3, referenced in current Section 21.4.5, is based on V_u under either nominal moment strength or two times the code prescribed earthquake force. The required shear strength in 21.6.5.1, referenced in Section 21.9.10.2 (IBC 1908.1.4), is based on the probable shear strength, V_e under the probable moment strength, M_{pr} . In addition, the spacing of required shear reinforcement is 8 inches on center under current Section 21.4.5 instead of 6 inches on center with seismic hooks at both ends under Section 21.9.10.2. Requirement of wall pier under Section 21.9.10.2 would enhance better ductility.

Current practice in commercial buildings constructed using precast panels wall system have large window and door openings and/or narrow wall piers. Wall panels varying up to three stories high with openings resembles wall frame which is not currently recognized under any of the defined seismic-force resisting systems other than consideration of structural wall system. Conformance to special structural wall system design and detailing of wall piers ensures minimum life safety performance in resisting earthquake forces for structures in Seismic Design Category D, E or F. Proposed modification separates wall piers designed for structures assigned to Seismic Design Category C from those assigned to Seismic Design Category D, E or F.

This modification is consistent with the amendment adopted by DSA-SS as reflected in Section 1916.4.4 of the 2010 Edition of the California Building Code; and reflects code change proposal approved for 2012 IBC during the 2009/2010 code development hearing.

FINDINGS:

Local Geological Conditions – The greater Los Angeles region is a densely populated area having buildings and structures constructed over and near a vast array of fault systems capable of producing major earthquakes, including but not limited to the recent 1994 Northridge Earthquake. The proposed modification to wall pier detailing is intended to assure that ductility requirements for high seismic region is provided and therefore needs to be incorporated into the code to assure that new buildings and structures and additions or alterations to existing buildings or structures are designed and constructed in accordance with the scope and objectives of the International Building Code and ACI 318.

2010 LARUCP 19-04. Section 1908.1.8 of the 2010 Edition of the California Building Code is amended to read as follows:

1908.1.8 ACI 318, Section 22.10. Delete ACI 318, Section 22.10, and replace with the following:

22.10 – Plain concrete in structures assigned to Seismic Design Category C, D, E or F.

22.10.1 – Structures assigned to Seismic Design Category C, D, E or F shall not have elements of structural plain concrete, except as follows:

(a) ~~Structural plain concrete basement, foundation or other walls below the base are permitted in detached one- and two-family dwellings three stories or less in height constructed with stud-bearing walls. In dwellings assigned to Seismic Design Category D or E, the height of the wall shall not exceed 8 feet (2438 mm), the thickness shall not be less than 7½ inches (190 mm), and the wall shall retain no more than 4 feet (1219 mm) of unbalanced fill. Walls shall have reinforcement in accordance with 22.6.6.5. Concrete used for fill with a minimum cement content of two (2) sacks of Portland cement per cubic yard.~~

(b) Isolated footings of plain concrete supporting pedestals or columns are permitted, provided the projection of the footing beyond the face of the supported member does not exceed the footing thickness.

~~Exception: In detached one- and two-family dwellings three stories or less in height, the projection of the footing beyond the face of the supported member is permitted to exceed the footing thickness.~~

(c) Plain concrete footings supporting walls are permitted provided the footings have at least two continuous longitudinal reinforcing bars. Bars shall not be smaller than No. 4 and shall have a total area of not less than 0.002 times the gross cross-sectional area of the footing. ~~For footings that exceed 8 inches (203 mm) in thickness, a~~ minimum of one bar shall be provided at the top and bottom of the footing. Continuity of reinforcement shall be provided at corners and intersections.

~~Exceptions:~~

~~1. In detached one- and two-family dwellings three stories or less in height and constructed with stud-bearing walls, plain concrete footings without longitudinal reinforcement supporting walls are permitted with at least two continuous longitudinal reinforcing bars not smaller than No. 4 are permitted to have a total area of less than 0.002 times the gross cross-sectional area of the footing.~~

~~2. For foundation systems consisting of a plain concrete footing and a plain concrete stemwall, a minimum of one bar shall be provided at the top of the stemwall and at the bottom of the footing.~~

~~3. Where a slab on ground is cast monolithically with the footing, one No. 5 bar is permitted to be located at either the top of the slab or bottom of the footing.~~

RATIONALE:

This proposed amendment requires minimum reinforcement in continuous footings to address the problem of poor performance of plain or under-reinforced footings during a seismic event. This amendment reflects the recommendations by the Structural Engineers Association of Southern California (SEAOSC) and the Los Angeles City Joint Task Force that investigated the poor performance observed in 1994 Northridge Earthquake. This proposed amendment is a continuation of an amendment adopted during previous code adoption cycles.

FINDINGS:

Local Geological Conditions – The greater Los Angeles region is a densely populated area having buildings and structures constructed over and near a vast array of fault systems capable of producing major earthquakes, including but not limited to the recent 1994 Northridge Earthquake. The proposed modification to require minimum reinforcement to address the problem of poor performance of plain or under-reinforced footings during a seismic event and therefore need to be incorporated into the code to assure that new buildings and structures and additions or alterations to existing buildings or structures are designed and constructed in accordance with the scope and objectives of the International Building Code.

2010 LARUCP 19-05. Section 1909.4 of the 2010 Edition of the California Building Code is amended to read as follows:

1909.4 Design. Structural plain concrete walls, footings and pedestals shall be designed for adequate strength in accordance with ACI 318, Section 22.4 through 22.8.

Exception: For Group R-3 occupancies and buildings or other occupancies less than two stories above grade plane of light-frame construction, the required edge thickness of ACI 318 is permitted to be reduced to 6 inches (152 mm), provided that the footing does not extend more than 4 inches (102 mm) on either side of the supported wall. This exception shall not apply to structural elements designed to resist seismic lateral forces for structures assigned to Seismic Design Category D, E or F.

RATIONALE:

With the higher seismic demand placed on buildings and structures in this region, the proposed amendment takes the precautionary steps to reduce or eliminate potential problems that may result permitting a reduced edge thickness of the footing that support walls without taking into consideration the surrounding environment. In addition, no substantiating data has been provided to show that the reduced edge thickness is effective in resisting seismic loads and may potentially lead to a higher risk of failure. It is important that the benefit and expertise of a registered design professional be obtained to properly analyze the structure and take these issues into consideration.

FINDINGS:

Local Geological Conditions – The greater Los Angeles region is a densely populated area having buildings and structures constructed over and near a vast array of fault systems capable of producing major earthquakes, including but not limited to the recent 1994 Northridge Earthquake. The proposed modification to prohibit the reduced edge thickness of footings supporting walls is intended to ensure that the proper analysis of the structure takes into account the surrounding condition and therefore need to be incorporated into the code to assure that new buildings and structures and additions or alterations to existing buildings or structures are designed and constructed in accordance with the scope and objectives of the International Building Code.

2010 LARUCP 22-01. Section 2204.1.1 is added to Chapter 22 of the 2010 Edition of the California Building Code to read as follows:

2204.1.1 Consumables for welding.

2204.1.1.1 Seismic Force Resisting System (SFRS) welds. All welds used in members and connections in the SFRS shall be made with filler metals meeting the requirements specified in AWS D1.8 Clause 6.3. AWS D1.8 Clauses 6.3.5, 6.3.6, 6.3.7 and 6.3.8 shall apply only to demand critical welds.

2204.1.1.2 Demand critical welds. Where welds are designated as demand critical, they shall be made with filler metals meeting the requirements specified in AWS D1.8 Clause 6.3.

RATIONALE:

A number of significant technical modifications have been made since the adoption of AISC 341-05. One such change incorporates AWS D1.8/D1.8M by reference for welding related issues. This change will be included in AISC 341-10 that is to be incorporated by reference into the 2012 Edition of the International Building Code. This proposed amendment is consistent with actions taken by both DSA-SS and OSHPD to incorporate such language in the 2010 Edition of the California Building Code.

AWS D1.8/D1.8M requires that all seismic force resisting system welds be made with filler metals classified using AWS A5 standards that achieve the following mechanical properties:

Filler Metal Classification Properties for Seismic Force Resisting System Welds		
Property	Classification	
	70 ksi (480 MPa)	80 ksi (550 MPa)
Yield Strength, ksi (MPa)	58 (400) min.	68 (470) min.
Tensile Strength, ksi (MPa)	70 (480) min.	80 (550) min.
Elongation, %	22 min.	19 min.
CVN Toughness, ft-lbf (J)	20 (27) min. @ 0 °F (-18 °C) ^a	
^a Filler metals classified as meeting 20 ft-lbf (27 J) min. at a temperature lower than 0 °F (-18 °C) also meet this requirement.		

In addition to the above requirements, AWS D1.8/D1.8M requires, unless otherwise exempted from testing, that all demand critical welds are to be made with filler metals receiving Heat Input Envelope Testing that achieve the following mechanical properties in the weld metal:

Mechanical Properties for Demand Critical Welds		
Property	Classification	
	70 ksi (480 MPa)	80 ksi (550 MPa)
Yield Strength, ksi (MPa)	58 (400) min.	68 (470) min.
Tensile Strength, ksi (MPa)	70 (480) min.	80 (550) min.
Elongation (%)	22 min.	19 min.
CVN Toughness, ft-lbf (J)	40 (54) min. @ 70 °F (20 °C) ^{b, c}	
^b For LAST of +50 °F (+10 °C). For LAST less than + 50 °F (+10 °C), see AWS D1.8/D1.8M Clause 6.3.6. ^c Tests conducted in accordance to AWS D1.8/D1.8M Annex A meeting 40 ft-lbf (54 J) min. at a temperature lower than +70 °F (20 °C) also meet this requirement.		

FINDINGS:

Local Geological Conditions – The greater Los Angeles region is a densely populated area having buildings and structures constructed over and near a vast array of fault systems capable of producing major earthquakes, including but not limited to the recent 1994 Northridge Earthquake. The proposed amendment is consistent with requirements in AISC 341-10 for improving quality of critical welds and therefore needs to be incorporated into the code to assure that new buildings and structures and additions or alterations to existing buildings or structures are designed and constructed in accordance with the scope and objectives of the International Building Code and ASCE 7-05.

2010 LARUCP 22-02. Section 2205.4 is added to Chapter 22 of the 2010 Edition of the California Building Code to read as follows:

2205.4 AISC 341, Part I, Section 13.2 Members. Add Section 13.2f to read as follows:

13.2f. Member Types

The use of rectangular HSS are not permitted for bracing members, unless filled solid with cement grout having a minimum compressive strength of 3,000 psi (20.7 MPa) at 28 days. The effects of composite action in the filled composite brace shall be considered in the sectional properties of the system where it results in the more severe loading condition or detailing.

RATIONALE:

Past test results on braces used in steel concentrically braced frames (SCBF) indicated that many commonly used sections and brace configurations do not meet seismic performance expectations. Specific parameters that were shown to affect the ductility of braces included net-section, section type, width-thickness ratio of the cross section and member slenderness. Square and rectangular cross-section HSS were shown to be particularly susceptible to fracture due to local buckling behavior of the cross section and, therefore, are not recommended by SEAOSC Seismology and Steel Committee for special concentric braced frame applications. Grout-filled HSS members exhibit more favorable local buckling characteristics, significantly altering the post-yield behavior of these sections. Both SEAOSC Seismology and Steel Committee recommended this modification during the 2007 code amendment process. This recommendation is a continuation of the proposal adopted in 2007. Furthermore, OSPHD has taken the same position and is continuing this recommendation as reflected in Section 2205A.4.1.5.1 to Chapter 22 of the 2010 Edition of the California Building Code. This proposed amendment is a continuation of an amendment adopted during previous code adoption cycles.

References:

1. AISC. 2005. Seismic Provisions for Structural Steel Buildings, American Institute of Steel Construction Inc., Chicago, IL.
2. Fell, B., Kanvinde, A., Deierlein, G., Myers, A., Fu, X. 2006. "Buckling and fracture of concentric braces under inelastic cyclic loading" Structural Steel Education Council, Steel Tips No.94.
3. Liu, Z., and Goel, S. C. 1988. "Cyclic Load Behavior of Concrete-Filled Tubular Braces." Journal of Structural Engineering 114 (7), 1488-1506.
4. Shaback, B., and Brown, T. 2003. "Behavior of square hollow structural steel braces with end connections under reversed cyclic axial loading." Canadian Journal of Civil Engineering 30, 745-753.
5. Tremblay, R., Archambault, M-H., and Filiatrault, A. 2003. "Seismic Response of Concentrically Brace Steel Frames Made with Rectangular Hollow Bracing Members." Journal of Structural Engineering 129 (12), 1626-1636.
6. Uriz, P., and Mahin, S.A. 2004. "Seismic Performance Assessment of Concentrically Braced Steel Frames." Proceedings of the 13th World Conference on Earthquake Engineering.

FINDINGS:

Local Geological Conditions – The greater Los Angeles region is a densely populated area having buildings and structures constructed over and near a vast array of fault systems capable of producing major earthquakes, including but not limited to the recent 1994 Northridge Earthquake. The proposed amendment is intended to reduce and minimize fracture of rectangular and square brace frame members due to local buckling behavior of the cross section and therefore needs to be incorporated into the code to assure that new buildings and structures and additions or alterations to existing buildings or structures are designed and constructed in accordance with the scope and objectives of the International Building Code and ASCE 7-05.

2010 LARUCP 23-01. Section 2304.11.7 of the 2010 Edition of the California Building Code is amended to read as follows:

2304.11.7 Wood used in retaining walls and cribs. Wood installed in retaining or crib walls shall be preservative treated in accordance with AWPA U1 (Commodity Specifications A or F) for soil and fresh water use. Wood shall not be used in retaining or crib walls for structures assigned to Seismic Design Category D, E or F.

RATIONALE:

No substantiating data has been provided to show that wood used in retaining or crib walls are effective in supporting buildings and structures during a seismic event while being subject to deterioration caused by the combined detrimental effect of constant moisture in the soil and wood-destroying organisms. Wood used in retaining or crib walls, when they are not properly treated and protected against deterioration, have performed very poorly. Most contractors are typically accustomed to construction in dry and temperate weather in the Southern California region and are not generally familiar with the necessary precautions and treatment of wood that makes it suitable for both seismic event and wet applications. The proposed amendment takes the precautionary steps to reduce or eliminate potential problems that may result by using wood in retaining or crib walls that experience relatively rapid decay due to the fact that the region does not experience temperatures cold enough to destroy or retard the growth and proliferation of wood-destroying organisms. This proposed amendment is a continuation of an amendment adopted during previous code adoption cycles.

FINDINGS:

Local Climatic and Geological Conditions – The greater Los Angeles region is a densely populated area having buildings and structures constructed over and near a vast array of fault systems capable of producing major earthquakes, including but not limited to the recent 1994 Northridge Earthquake. In addition, the region is within a climate system capable of producing major winds, fire and rain related disasters, including but not limited to those caused by the Santa Ana winds and El Nino (or La Nina) subtropical-like weather. This region is especially susceptible to more active termite and wood attacking insects and microorganisms. The proposed modification to prohibit the use of wood in retaining or crib walls in an effort to mitigate potential problems or deficiencies due to the proliferation of wood-destroying organisms and therefore need to be incorporated into the code to assure that new buildings and structures and additions or alterations to existing buildings or structures are designed and constructed in accordance with the scope and objectives of the International Building Code.

FY 2010 LOS ANGELES REGION UNIFORM CODE PROGRAM (LARUCP)

2010 LARUCP 23-02. Section 2305.4 is added to Chapter 23 of the 2010 Edition of the California Building Code to read as follows:

2305.4 Quality of Nails. In Seismic Design Category D, E or F, mechanically driven nails used in wood structural panel shear walls shall meet the same dimensions as that required for hand-driven nails, including diameter, minimum length and minimum head diameter. Clipped head or box nails are not permitted in new construction. The allowable design value for clipped head nails in existing construction may be taken at no more than the nail-head-area ratio of that of the same size hand-driven nails.

RATIONALE:

The overdriving of nails into the structural wood panel still remains a concern when pneumatic nail guns are used for wood structural panel shear wall nailing. Box nails were observed to cause massive and multiple failures of the typical 3/8-inch thick plywood during the 1994 Northridge Earthquake. The use of clipped head nails continues to be restricted from being used in wood structural panel shear walls where the minimum nail head size must be maintained in order to minimize nails from pulling through sheathing materials. Clipped or mechanically driven nails used in wood structural panel shear wall construction were found to perform much less in previous wood structural panel shear wall testing done at the University of California Irvine. The existing test results indicated that, under cyclic loading, the wood structural panel shear walls were less energy absorbent and less ductile. The panels reached ultimate load capacity and failed at substantially less lateral deflection than those using same size hand-driven nails. This amendment reflects the recommendations by the Structural Engineers Association of Southern California (SEAOSC) and the Los Angeles City Joint Task Force that investigated the poor performance observed in 1994 Northridge Earthquake. This proposed amendment is a continuation of an amendment adopted during previous code adoption cycles.

FINDINGS:

Local Geological Conditions – The greater Los Angeles region is a densely populated area having buildings and structures constructed over and near a vast array of fault systems capable of producing major earthquakes, including but not limited to the recent 1994 Northridge Earthquake. The proposed modification to require mechanically driven nails to have the same dimensions as hand-driven nail will result in improved quality of construction and performance of wood structural panel shear walls and therefore need to be incorporated into the code to assure that new buildings and structures and additions or alterations to existing buildings or structures are designed and constructed in accordance with the scope and objectives of the International Building Code.

2010 LARUCP 23-03. Section 2305.5 is added to Chapter 23 of the 2010 Edition of the California Building Code to read as follows:

2305.5 Hold-down connectors. In Seismic Design Category D, E or F, hold-down connectors shall be designed to resist shear wall overturning moments using approved cyclic load values or 75 percent of the allowable seismic load values that do not consider cyclic loading of the product. Connector bolts into wood framing shall require steel plate washers on the post on the opposite side of the anchorage device. Plate size shall be a minimum of 0.229 inch by 3 inches by 3 inches (5.82 mm by 76 mm by 76 mm) in size. Hold-down connectors shall be tightened to finger tight plus one half (1/2) wrench turn just prior to covering the wall framing.

RATIONALE:

Many of the hold-down connectors currently in use do not have any acceptance report based on dynamic testing protocol. This proposed amendment continues to limit the allowable capacity to 75% of the acceptance report value to provide an additional factor of safety for statically tested anchorage devices. Cyclic forces imparted on buildings and structures by seismic activity cause more damage than equivalent forces that are applied in a static manner. Steel plate washers will reduce the additional damage that can result when hold-down connectors are fastened to wood framing members. This amendment reflects the recommendations by the Structural Engineers Association of Southern California (SEAOSC) and the Los Angeles City Joint Task Force that investigated the poor performance observed in 1994 Northridge Earthquake. This proposed amendment is a continuation of an amendment adopted during previous code adoption cycles.

FINDINGS:

Local Geological Conditions – The greater Los Angeles region is a densely populated area having buildings and structures constructed over and near a vast array of fault systems capable of producing major earthquakes, including but not limited to the recent 1994 Northridge Earthquake. The proposed modification to establish minimum performance requirements for hold-down connectors will reduce failure of wood structural panel shear walls due to excessive deflection and therefore need to be incorporated into the code to assure that new buildings and structures and additions or alterations to existing buildings or structures are designed and constructed in accordance with the scope and objectives of the International Building Code.

2010 LARUCP 23-04. Tables 2306.2.1(3) and 2306.2.1(4) are added to Chapter 23 of the 2010 Edition of the California Building Code and Section 2306.2.1 of the 2010 Edition of the California Building Code is amended to read as follows:

2306.2.1 Wood structural panel diaphragms. Wood structural panel diaphragms shall be designed and constructed in accordance with AF&PA SDPWS. Wood structural panel diaphragms are permitted to resist horizontal forces using the allowable shear capacities set forth in Table 2306.2.1(1) or 2306.2.1(2). For structures assigned to Seismic Design Category D, E or F, the allowable shear capacities shall be set forth in Table 2306.2.1(3) or 2306.2.1(4). The allowable shear capacities in Table 2306.2.1(1) or 2306.2.1(2) are permitted to be increased 40 percent for wind design.

Wood structural panel diaphragms fastened with staples shall not used to resist seismic forces in structures assigned to Seismic Design Category D, E or F.

Exception: Staples may be used for wood structural panel diaphragms when the allowable shear values are substantiated by cyclic testing and approved by the building official.

Wood structural panel diaphragms used to resist seismic forces in structures assigned to Seismic Design Category D, E or F shall be applied directly to the framing members.

Exception: Wood structural panel diaphragm is permitted to be fastened over solid lumber planking or laminated decking, provided the panel joints and lumber planking or laminated decking joints do not coincide.

TABLE 2306.2.1(3)
ALLOWABLE SHEAR (POUNDS PER FOOT) FOR WOOD STRUCTURAL PANEL DIAPHRAGMS WITH
FRAMING OF DOUGLAS FIR-LARCH OR SOUTHERN PINE^a FOR SEISMIC LOADING^f
FOR STRUCTURES ASSIGNED TO SEISMIC DESIGN CATEGORY D, E OR F

PANEL GRADE	COMMON NAIL SIZE	MINIMUM FASTENER PENETRATION IN FRAMING (inches)	MINIMUM NOMINAL PANEL THICKNESS (inch)	MINIMUM NOMINAL WIDTH OF FRAMING MEMBERS AT ADJOINING PANEL EDGES AND BOUNDARIES ^e (inches)	BLOCKED DIAPHRAGMS				UNBLOCKED DIAPHRAGMS	
					Fastener spacing (inches) at diaphragm boundaries (all cases) at continuous panel edges parallel to load (Cases 3,4), and at all panel edges (Cases 5, 6) ^b				Fastener spaced 6" max. at supported edges ^b	
					6	4	2 1/2 ^c	2 ^c	Case 1 (No unblocked edges or continuous joints parallel to load)	All other configurations (Cases 2, 3, 4, 5 and 6)
					Fastener spacing (inches) at other panel edges (Cases 1,2,3 and 4) ^b					
6	6	4	3							
Structural I Grades	8d (2 1/2" x 0.131")	1 3/8	3/8	2	270	360	530	600	240	180
				3	300	400	600	675	265	200
	10d ^d (3" x 0.148")	1 1/2	15/32	2	320	425	640	730	285	215
				3	360	480	720	820	320	240
Sheathing, single floor and other grades covered in DOC PS1 and PS2	6d ^e (2" x 0.113")	1 1/4	3/8	2	185	250	375	420	165	125
				3	210	280	420	475	185	140
	8d (2 1/2" x 0.131")	1 3/8	7/16	2	240	320	480	545	215	160
				3	270	360	540	610	240	180
	8d (2 1/2" x 0.131")	1 3/8	15/32	2	255	340	505	575	230	170
				3	285	380	570	645	255	190
	8d (2 1/2" x 0.131")	1 3/8	15/32	2	270	360	530	600	240	180
				3	300	400	600	675	265	200
	10d ^d (3" x 0.148")	1 1/2	15/32	2	290	385	575	655	255	190
				3	324	430	650	735	290	215
10d ^d (3" x 0.148")	1 1/2	19/32	2	320	425	640	730	285	215	
			3	360	480	720	820	320	240	

TABLE 2306.2.1(3)–continued
ALLOWABLE SHEAR (POUNDS PER FOOT) FOR WOOD STRUCTURAL
PANEL DIAPHRAGMS WITH FRAMING OF DOUGLAS FIR-LARCH,
OR SOUTHERN PINE^a FOR SEISMIC LOADING^f
FOR STRUCTURES ASSIGNED TO SEISMIC DESIGN CATEGORY D, E OR F

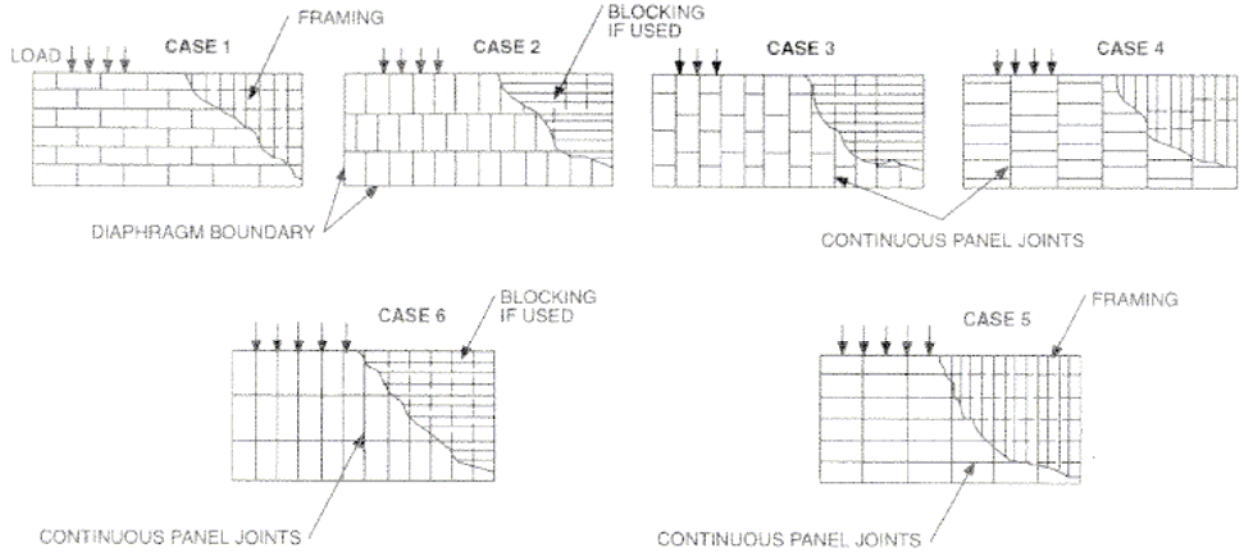

For SI: 1 inch = 25.4 mm, 1 pound per foot = 14.5939 N/m.

- For framing of other species: (1) Find specific gravity for species of lumber in AF&PA NDS. (2) For nails find shear value from table above for nail size for actual grade and multiply value by the following adjustment factor: Specific Gravity Adjustment Factor = $[1 - (0.5 - SG)]$, where SG = Specific Gravity of the framing lumber. This adjustment factor shall not be greater than 1.
- Space fasteners maximum 12 inches o.c. along intermediate framing members (6 inches o.c. where supports are spaced 48 inches o.c.).
- Framing at adjoining panel edges shall be 3 inches nominal or thicker, and nails at all panel edges shall be staggered where panel edge nailing is specified at 2 ½ inches o.c. or less.
- Framing at adjoining panel edges shall be 3 inches nominal or thicker, and nails at all panel edges shall be staggered where both of the following conditions are met: (1) 10d nails having penetration into framing of more than 1 ½ inches and (2) panel edge nailing is specified at 3 inches o.c. or less.
- The minimum nominal width of framing members not located at boundaries or adjoining panel edges shall be 2 inches.
- For shear loads of normal or permanent load duration as defined by the AF&PA NDS, the values in the table above shall be multiplied by 0.63 or 0.56, respectively.

TABLE 2306.2.1(4)
ALLOWABLE SHEAR (POUNDS PER FOOT) FOR WOOD STRUCTURAL PANEL BLOCKED DIAPHRAGMS
UTILIZING MULTIPLE ROWS OF FASTENERS (HIGH LOAD DIAPHRAGMS) WITH FRAMING OF DOUGLAS
FIR-LARCH OR SOUTHERN PINE^a FOR SEISMIC LOADING^{b,f,g}
FOR STRUCTURES ASSIGNED TO SEISMIC DESIGN CATEGORY D, E OR F

<u>PANEL GRADE^c</u>	<u>COMMON NAIL SIZE</u>	<u>MINIMUM FASTENER PENETRATION IN FRAMING (inches)</u>	<u>MINIMUM NOMINAL PANEL THICKNESS (inch)</u>	<u>MINIMUM NOMINAL WIDTH OF FRAMING MEMBERS AT ADJOINING PANEL EDGES AND BOUNDARIES^e (inches)</u>	<u>LINES OF FASTENERS</u>	<u>BLOCKED DIAPHRAGMS</u>			
						<u>Cases 1 and 2^d</u>			
						<u>Fastener Spacing Per Line at Boundaries (inches)</u>			
						<u>4</u>	<u>2 1/2</u>		
						<u>Fastener Spacing Per Line at Other Panel Edges (inches)</u>			
<u>6</u>	<u>4</u>	<u>4</u>	<u>3</u>						
Structural I grades	10d common nails	1 1/2	15/32	3	2	605	815	875	1,150
				4	2	700	915	1,005	1,290
				4	3	875	1,220	1,285	1,395
			19/32	3	2	670	880	965	1,255
				4	2	780	990	1,110	1,440
				4	3	965	1,320	1,405	1,790
			23/32	3	2	730	955	1,050	1,365
				4	2	855	1,070	1,210	1,565
				4	3	1,050	1,430	1,525	1,800
Sheathing, single floor and other grades covered in DOC PS1 and PS2	10d common nails	1 1/2	15/32	3	2	525	725	765	1,010
				4	2	605	815	875	1,105
				4	3	765	1,085	1,130	1,195
			19/32	3	2	650	860	935	1,225
				4	2	755	965	1,080	1,370
				4	3	935	1,290	1,365	1,485
			23/32	3	2	710	935	1,020	1,335
				4	2	825	1,050	1,175	1,445
				4	3	1,020	1,400	1,480	1,565

For SI: 1 inch = 25.4 mm, 1 pound per foot = 14.5939 N/m.

- For framing of other species: (1) Find specific gravity for species of lumber in AF&PA NDS. (2) For nails find shear value from table above for nail size for actual grade and multiply value by the following adjustment factor: Specific Gravity Adjustment Factor = [1-(0.5-SG)], where SG = Specific Gravity of the framing lumber. This adjustment factor shall not be greater than 1.
- Fastening along intermediate framing members: Space fasteners a maximum of 12 inches on center, except 6 inches on center for spans greater than 32 inches.
- Panels conforming to PS1 or PS 2.
- This table gives shear values for Cases 1 and 2 as shown in Table 2306.2.1(3). The values shown are applicable to Cases 3, 4, 5 and 6 as shown in Table 2306.2.1(3), providing fasteners at all continuous panels edges are spaced in accordance with the boundary fastener spacing.
- The minimum nominal depth of framing members shall be 3 inches nominal. The minimum nominal width of framing members not located at boundaries or adjoining panel edges shall be 2 inches.
- High load diaphragms shall be subject to special inspection in accordance with Section 1704.6.1.
- For shear loads of normal or permanent load duration as defined by the AF&PA NDS, the values in the table above shall be multiplied by 0.63 or 0.56, respectively.

TABLE 2306.2.1(4)—continued
ALLOWABLE SHEAR (POUNDS PER FOOT) FOR WOOD STRUCTURAL PANEL BLOCKED DIAPHRAGMS
UTILIZING MULTIPLE ROWS OF FASTENERS (HIGH LOAD DIAPHRAGMS) WITH FRAMING OF DOUGLAS
FIR-LARCH OR SOUTHERN PINE^a FOR SEISMIC LOADING^{b,1,9}
FOR STRUCTURES ASSIGNED TO SEISMIC DESIGN CATEGORY D, E OR F

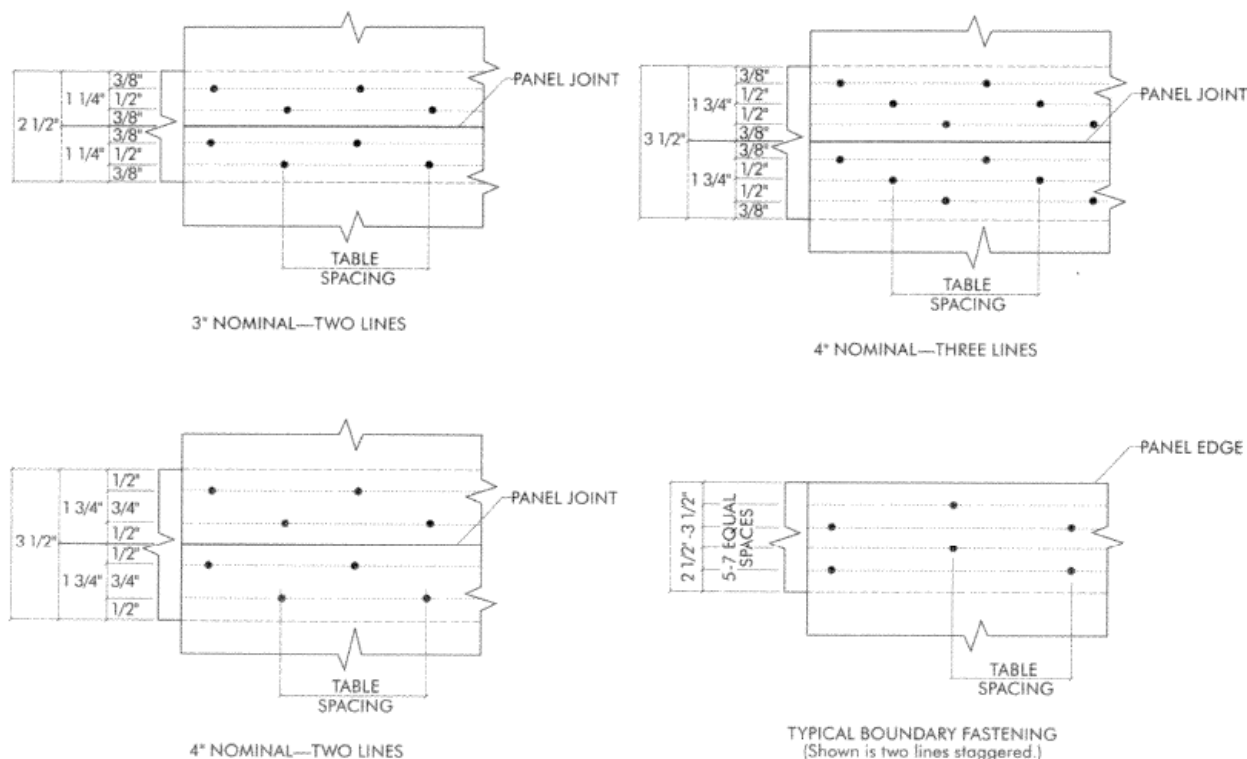

NOTE: SPACE PANEL END AND EDGE JOINT 1/8-INCH. REDUCE SPACING BETWEEN LINES OF NAILS AS NECESSARY TO MAINTAIN MINIMUM 3/8-INCH FASTENER EDGE MARGINS, MINIMUM SPACING BETWEEN LINES IS 3/8-INCH

RATIONALE:

The Structural Engineers Association of Southern California (SEAOSC) and the Los Angeles City Joint Task Force that investigated the damages to buildings and structures during the 1994 Northridge Earthquake recommended reducing allowable shear values in wood structural panel shear walls or diaphragms that were not substantiated by cyclic testing. That recommendation was consistent with a report to the Governor from the Seismic Safety Commission of the State of California recommending that code requirements be "more thoroughly substantiated with testing." The allowable shear values for wood structural panel shear walls or diaphragms fastened with staples are based on monotonic testing and does not take into consideration that earthquake forces load shear wall or diaphragm in a repeating and fully reversible manner.

In September 2007, limited cyclic testing was conducted by a private engineering firm to determine if wood structural panels fastened with staples would exhibit the same behavior as the wood structural panels fastened with common nails. The test result revealed that wood structural panel fastened with staples appeared to be much lower in strength and stiffness than wood structural panels fastened with common nails. It was recommended that the use of staples as fasteners for wood structural panel shear walls or diaphragms not be permitted to resist seismic forces in structures assigned to Seismic Design Category D, E and F unless it can be substantiated by cyclic testing.

Furthermore, the cities and county within the Los Angeles region has taken extra measures to maintain the structural integrity of the framing of shear walls and diaphragms designed for high levels of seismic forces by requiring wood sheathing be applied directly over the framing members and prohibiting the use of panels placed over gypsum sheathing. This proposed amendment is intended to prevent the undesirable performance of nails when gypsum board softens due to cyclic earthquake displacements and the nail ultimately does not have any engagement in a solid material within the thickness of the gypsum board.

This proposed amendment continues the previous amendment adopted during the 2007 code adoption cycle.

FINDINGS:

Local Geological Conditions – The greater Los Angeles region is a densely populated area having buildings and structures constructed over and near a vast array of fault systems capable of producing major earthquakes, including but not limited to the recent 1994 Northridge Earthquake. The proposed modification to place design and construction limits on staples as fasteners used in wood structural panel or diaphragms not substantiated with cyclic testing will help to maintain minimum quality of construction and performance standards of structures and therefore need to be incorporated into the code to assure that new buildings and structures and additions or alterations to existing buildings or structures are designed and constructed in accordance with the scope and objectives of the International Building Code.

2010 LARUCP 23-05. Table 2306.3(2) is added to Chapter 23 of the 2010 Edition of the California Building Code and Section 2306.3 and Table 2306.3 of the 2010 Edition of the California Building Code are amended to read as follows:

2306.3 Wood structural panel shear walls. Wood structural panel shear walls shall be designed and constructed in accordance with AF&PA SDPWS. Wood structural panel shear walls are permitted to resist horizontal forces using the allowable shear capacities set forth in Table 2306.3(1). For structures assigned to Seismic Design Category D, E or F, the allowable shear capacities shall be set forth in Table 2306.3(2). The allowable shear capacities in Table 2306.3(1) are permitted to be increased 40 percent for wind design.

Wood structural panel shear walls used to resist seismic forces in structures assigned to Seismic Design Category D, E or F shall not be less than 4 feet by 8 feet (1219 mm by 2438 mm), except at boundaries and at changes in framing. Wood structural panel thickness for shear walls shall not be less than 3/8 inch thick and studs shall not be spaced at more than 16 inches on center.

The maximum allowable shear value for three-ply plywood resisting seismic forces in structures assigned to Seismic Design Category D, E or F is 200 pounds per foot (2.92 kn/m). Nails shall be placed not less than 1/2 inch (12.7 mm) in from the panel edges and not less than 3/8 inch (9.5mm) from the edge of the connecting members for shear greater than 350 pounds per foot (5.11kN/m). Nails shall be placed not less than 3/8 inch (9.5 mm) from panel edges and not less than 1/4 inch (6.4 mm) from the edge of the connecting members for shears of 350 pounds per foot (5.11kN/m) or less.

Wood structural panel shear walls fastened with staples shall not used to resist seismic forces in structures assigned to Seismic Design Category D, E or F.

Exception: Staples may be used for wood structural panel shear walls when the allowable shear values are substantiated by cyclic testing and approved by the building official.

Wood structural panel shear walls used to resist seismic forces in structures assigned to Seismic Design Category D, E or F shall be applied directly to the framing members.

TABLE 2306.3(1)
ALLOWABLE SHEAR (POUNDS PER FOOT) FOR WOOD STRUCTURAL PANEL SHEAR WALLS WITH FRAMING OF DOUGLAS FIR-LARCH OR SOUTHERN PINE^a FOR WIND OR SEISMIC LOADING^{b, h, i, j, l, m, n}

TABLE 2306.3(2)
ALLOWABLE SHEAR (POUNDS PER FOOT) FOR WOOD STRUCTURAL PANEL SHEAR WALLS WITH
FRAMING OF DOUGLAS FIR-LARCH OR SOUTHERN PINE^a FOR SEISMIC LOADING^{b, h, j, k, l}
FOR STRUCTURES ASSIGNED TO SEISMIC DESIGN CATEGORY D, E OR F

PANEL GRADE	MINIMUM NOMINAL PANEL THICKNESS (inch)	MINIMUM FASTENER PENETRATION IN FRAMING (inches)	ALLOWABLE SHEAR VALUE FOR SEISMIC FORCES PANELS APPLIED DIRECTLY TO FRAMING				
			COMMON NAIL SIZE	Fastener spacing at panel edges (inches)			
				6	4	3	2 ^e
Structural I sheathing	3/8	1 3/8	8d (2½"x0.131" common)	200	200	200	200
	7/16	1 3/8	8d (2½"x0.131" common)	255	395	505	670
	15/32	1 3/8	8d (2½"x0.131" common)	280	430	550	730
		1 1/2	10d (3"x0.148" common)	340	510	665 ^f	870
Sheathing, plywood siding ^g except Group 5 Species	3/8 ^c	1 3/8	8d (2½"x0.113")	160	200	200	200

For SI: 1 inch = 25.4 mm, 1 foot = 25.4 mm, 1 pound per foot = 14.5939 N/m.

- For framing of other species: (1) Find specific gravity for species of lumber in AF&PA NDS. (2) For nails find shear value from table above for nail size for actual grade and multiply value by the following adjustment factor: Specific Gravity Adjustment Factor = [1-(0.5-SG)], where SG = Specific Gravity of the framing lumber. This adjustment factor shall not be greater than 1.
- Panel edges backed with 2-inch nominal or thicker framing. Install panels either horizontally or vertically. Space fasteners maximum 6 inches on center along intermediate framing members for 3/8-inch and 7/16-inch panels installed on studs spaced 24 inches on center. For other conditions and panel thickness, space fasteners maximum 12 inches on center on intermediate supports.
- 3/8-inch panel thickness or siding with a span rating of 16 inches on center is the minimum recommended where applied direct to framing as exterior siding. For grooved panel siding, the nominal panel thickness is the thickness of the panel measured at the point of nailing.
- Allowable shear values are permitted to be increased to values shown for 15/32-inch sheathing with same nailing provided (a) studs are spaced a maximum of 16 inches on center, or (b) panels are applied with long dimension across studs.
- Framing at adjoining panel edges shall be 3 inches nominal or thicker, and nails shall be staggered where nails are spaced 2 inches on center or less.
- Framing at adjoining panel edges shall be 3 inches nominal or thicker, and nails shall be staggered where both of the following conditions are met: (1) 10d (3"x0.148") nails having penetration into framing of more than 1-1/2 inches and (2) nails are spaced 3 inches on center or less.
- Values apply to all-veneer plywood. Thickness at point of fastening on panel edges governs shear values.
- Where panels applied on both faces of a wall and nail spacing is less than 6 inches o.c. on either side, panel joints shall be offset to fall on different framing members. Or framing shall be 3-inch nominal or thicker at adjoining panel edges and nails at all panel edges shall be staggered.
- Where shear design values exceed 350 pounds per linear foot, all framing members receiving edge nailing from abutting panels shall not be less than a single 3-inch nominal member, or two 2-inch nominal members fastened together in accordance with Section 2306.1 to transfer the design shear value between framing members. Wood structural panel joint and sill plate nailing shall be staggered at all panel edges. See Section 4.3.6.1 and 4.3.6.4.3 of AF&PA SDPWS for sill plate size and anchorage requirements.
- Galvanized nails shall be hot dipped or tumbled.
- For shear loads of normal or permanent load duration as defined by the AF&PA NDS, the values in the table above shall be multiplied by 0.63 or 0.56, respectively.
- The maximum allowable shear value for three-ply plywood resisting seismic forces is 200 pounds per foot (2.92 kn/m).

RATIONALE:

The Structural Engineers Association of Southern California (SEAOSC) and the Los Angeles City Joint Task Force that investigated the damages to buildings and structures during the 1994 Northridge Earthquake recommended reducing allowable shear values in wood structural panel shear walls or diaphragms that were not substantiated by cyclic testing. That recommendation was consistent with a report to the Governor from the Seismic Safety Commission of the State of California recommending that code requirements be "more thoroughly substantiated with testing." The allowable shear values for wood structural panel shear walls or diaphragms fastened with stapled nails are based on monotonic testing and does not take into consideration that earthquake forces load shear wall or diaphragm in a repeating and fully reversible manner.

In September 2007, limited cyclic testing was conducted by a private engineering firm to determine if wood structural panels fastened with stapled nails would exhibit the same behavior as the wood structural panels fastened with common nails. The test result revealed that wood structural panel fastened with stapled nails appeared to be much lower in strength and stiffness than wood structural panels fastened with common nails. It was recommended that the use of stapled nail as fasteners for wood structural panel shear walls or diaphragms not be permitted to resist seismic forces in structures assigned to Seismic Design Category D, E and F unless it can be substantiated by cyclic testing.

Furthermore, the cities and county within the Los Angeles region has taken extra measures to maintain the structural integrity of the framing of shear walls and diaphragms designed for high levels of seismic forces by requiring wood sheathing be applied directly over the framing members and prohibiting the use of panels placed over gypsum sheathing. This proposed amendment is intended to prevent the undesirable performance of nails when gypsum board softens due to cyclic earthquake displacements and the nail ultimately does not have any engagement in a solid material within the thickness of the gypsum board.

This proposed amendment continues the previous amendment adopted during the 2007 code adoption cycle.

FINDINGS:

Local Geological Conditions – The greater Los Angeles region is a densely populated area having buildings and structures constructed over and near a vast array of fault systems capable of producing major earthquakes, including but not limited to the recent 1994 Northridge Earthquake. The proposed modification to place design and construction limits on stapled nail fasteners used in wood structural panel shear walls or diaphragms not substantiated with cyclic testing will help to maintain minimum quality of construction and performance standards of structures and therefore need to be incorporated into the code to assure that new buildings and structures and additions or alterations to existing buildings or structures are designed and constructed in accordance with the scope and objectives of the International Building Code.

2010 LARUCP 23-06. Section 2306.7 of the 2010 Edition of the California Building Code are amended to read as follows:

2306.7 Shear walls sheathed with other materials. Shear walls sheathed with portland cement plaster, gypsum lath, gypsum sheathing or gypsum board shall be designed and constructed in accordance with AF&PA SDPWS. Shear walls sheathed with these materials are permitted to resist horizontal forces using the allowable shear capacities set forth in Table 2306.7. Shear walls sheathed with portland cement plaster, gypsum lath, gypsum sheathing or gypsum board shall not be used to resist seismic forces in structures assigned to Seismic Design Category E or F.

Shear walls sheathed with lath, plaster or gypsum board shall not be used below the top level in a multi-level building for structures assigned to Seismic Design Category D.

RATIONALE:

Due to the high geologic activities in the Southern California area and the expected higher level of performance on buildings and structures, this proposed local amendment limits the location where shear walls sheathed with lath, plaster or gypsum board are used in multi-level buildings. The poor performance of such shear walls sheathed with other materials in the 1994 Northridge Earthquake was investigated by the Structural Engineers Association of Southern California (SEAOSC) and the Los Angeles City Task Force and formed the basis for this proposed amendment. Considering that shear walls sheathed with lath, plaster or gypsum board are less ductile than steel moment frames or wood structural panel shear walls, the cities and county of the Los Angeles region has taken the necessary measures to limit the potential structural damage that may be caused by the use of such walls at the lower level of multi-level building that are subject to higher levels of seismic loads. This proposed amendment is a continuation of an amendment adopted during previous code adoption cycles.

FINDINGS:

Local Geological Conditions – The greater Los Angeles region is a densely populated area having buildings and structures constructed over and near a vast array of fault systems capable of producing major earthquakes, including but not limited to the recent 1994 Northridge Earthquake. The proposed modification to limit the location where shear walls sheathed with lath, plaster or gypsum board are used will help to ensure that multi-level building will reach it's performance objective in resisting higher levels of seismic loads and therefore need to be incorporated into the code to assure that new buildings and structures and additions or alterations to existing buildings or structures are designed and constructed in accordance with the scope and objectives of the International Building Code.

2010 LARUCP 23-07. Section 2308.3.4 of Chapter 23 of the 2010 Edition of the California Building Code is amended to read as follows:

2308.3.4 Braced wall line support. Braced wall lines shall be supported by continuous foundations.

Exception: For structures with a maximum plan dimension not over 50 feet (15240 mm), continuous foundations are required at exterior walls only for structures not assigned to Seismic Design Category D, E or F.

RATIONALE:

With the higher seismic demand placed on buildings and structures in this region, interior walls can easily be called upon to resist over half of the seismic loading imposed on simple buildings or structures. Without a continuous foundation to support the braced wall line, seismic loads would be transferred through other elements such as non-structural concrete slab floors, wood floors, etc. The proposed change is to limit the use of the exception to structures assigned to Seismic Design Category A, B or C where lower seismic demands are expected. Requiring interior braced walls be supported by continuous foundations is intended to reduce or eliminate the poor performance of buildings or structures. This proposed amendment is a continuation of an amendment adopted during previous code adoption cycles.

FINDINGS:

Local Geological Conditions – The greater Los Angeles region is a densely populated area having buildings and structures constructed over and near a vast array of fault systems capable of producing major earthquakes, including but not limited to the recent 1994 Northridge Earthquake. Conventional framing does not address the need for a continuous load path, critical shear transfer mechanisms, connection-ties, irregular and flexible portions of complex shaped structures. The proposed modification to require continuous footings under braced wall lines will improve performance of buildings or structure during a seismic event and therefore need to be incorporated into the code to assure that new buildings and additions to existing buildings are designed and constructed in accordance with the scope and objectives of the International Building Code.

2010 LARUCP 23-08. Section 2308.12.2 of Chapter 23 of the 2010 Edition of the California Building Code is amended to read as follows:

2308.12.2 Concrete or masonry. Concrete or masonry walls and stone or masonry veneer shall not extend above the basement.

Exception: Stone and masonry veneer is permitted to be used in the first story above grade plane in Seismic Design Category D, provided the following criteria are met:

1. Type of brace in accordance with Section 2308.9.3 shall be Method 3 and the allowable shear capacity in accordance with Table 2306.4.1 shall be a minimum of 350 plf (5108 N/m).
2. The bracing of the first story shall be located at each end and at least every 25 feet (7620 mm) o.c. but not less than 45 percent of the braced wall line.
3. Hold-down connectors shall be provided at the ends of braced walls for the first floor to foundation with an allowable design of 2,100 pounds (9341 N).
4. Cripple walls shall not be permitted.
5. Anchored masonry and stone wall veneer shall not exceed 5 inches (127 mm) in thickness, shall conform to the requirements of Chapter 14 and shall not extend more than 5 feet (1524 mm) above the first story finished floor.

RATIONALE:

Additional weight attributed to the use of heavy veneer substantially increases loads to conventionally braced walls in an earthquake. Moreover, normal to wall loads that occur in an earthquake can seriously overstress wood bearing walls in combined seismic/gravity load combinations. Numerous conventionally framed veneer covered structures sustained serious damages in the Northridge Earthquake as a result of the heavy weight of the veneer. This proposed amendment is a continuation of an amendment adopted during previous code adoption cycles.

FINDINGS:

Local Geological Conditions – The greater Los Angeles region is a densely populated area having buildings and structures constructed over and near a vast array of fault systems capable of producing major earthquakes, including but not limited to the recent 1994 Northridge Earthquake. Conventional framing does not address the need for a continuous load path, critical shear transfer mechanisms, connection ties, irregular and flexible portions of complex shaped structures. Unless designed by a registered design professional, such buildings built by conventional framing requirements will be prone to serious damage in future large earthquakes. The proposed modification need to be incorporated into the code to assure that new buildings and additions to existing buildings are designed and constructed in accordance with the scope and objectives of the International Building Code.

2010 LARUCP 23-09. Section 2308.12.4 and Table 2308.12.4 of the 2010 Edition of the California Building Code are amended to read as follows:

2308.12.4 Braced wall line sheathing. Braced wall lines shall be braced by one of the types of sheathing prescribed by Table 2308.12.4 as shown in Figure 2308.9.3. The sum of lengths of braced wall panels at each braced wall line shall conform to Table 2308.12.4. Braced wall panels shall be distributed along the length of the braced wall line and start at not more than 8 feet (2438 mm) from each end of the braced wall line. Panel sheathing joints shall occur over studs or blocking. Sheathing shall be fastened to studs, top and bottom plates and at panel edges occurring over blocking. Wall framing to which sheathing used for bracing is applied shall be nominal 2 inch wide [actual 1½ inch (38 mm)] or larger members and spaced a maximum of 16 inches on center.

Exception: Braced wall panels required by Section 2308.12.4 may be eliminated when all of the following requirements are met:

1. One story detached Group U occupancies not more than 25 feet in depth or length.
2. The roof and three enclosing walls are solid sheathed with 15/32 inch nominal thickness wood structural panels with 8d common nails placed 3/8 inches from panel edges and spaced not more than 6 inches on center along all panel edges and 12 inches on center along intermediate framing members. Wall openings for doors or windows are permitted provided a minimum 4 foot wide wood structural braced panel with minimum height to length ratio of 2 to 1 is provided at each end of the wall line and that the wall line be sheathed for 50% of its length.

Wood structural panel sheathing shall be a minimum of 15/32 inch thick nailed with 8d common placed 3/8 inches from panel edges and spaced not more than 6 inches on center and 12 inches on center along intermediate framing members.

~~Cripple walls having a stud height exceeding 14 inches (356 mm) shall be considered a story for the purpose of this section and shall be braced as required for braced wall lines in accordance with Table 2309.12.4. Where interior braced wall lines occur without a continuous foundation below, the length of parallel exterior cripple wall bracing shall be one and one-half times the lengths required by Table 2308.12.4. Where the cripple wall sheathing type used is Type S-W and this additional length of bracing cannot be provided, the capacity of Type S-W sheathing shall be increased by reducing the spacing of fasteners along the perimeter of each piece of sheathing to 4 inches (102 mm) o.c.~~

Braced wall panel construction types shall not be mixed within a braced wall line.

**TABLE 2308.12.4
WALL BRACING IN SEISMIC DESIGN CATEGORIES D AND E
(Minimum Length of Wall Bracing per each 25 Linear Feet of Braced Wall Line ^a)**

CONDITION	SHEATHING TYPE ^b	$S_{DS} < 0.50$	$0.50 \leq S_{DS} < 0.75$	$0.75 \leq S_{DS} \leq 1.00$	$S_{DS} > 1.00$
One Story	G-P ^c	10 feet 8 inches	14 feet 8 inches	18 feet 8 inches	25 feet 0 inches
	S-W ^d	5 feet 4 inches	8 feet 0 inches	9 feet 4 inches	12 feet 0 inches

For SI: 1 inch = 25.4 mm, 1 foot = 304.8 mm.

- a. Minimum length of panel bracing of one face of the wall for S-W sheathing shall be at least 4'-0" long or both faces of the wall for G-P sheathing shall be at least 8'-0" long; h/w ratio shall not exceed 2:1. For S-W panel bracing of the same material on two faces of the wall, the minimum length is permitted to be one-half the tabulated value but the h/w ratio shall not exceed 2:1 and design for uplift is required.
- b. G-P = gypsum board, ~~fiberboard, particleboard, lath and portland cement plaster or gypsum sheathing boards~~; S-W = wood structural panels ~~and diagonal wood sheathing~~.
- c. Nailing as specified below shall occur at all panel edges at studs, at top and bottom plates and, where occurring, at blocking:
 For 1/2-inch gypsum board, 5d (0.113 inch diameter) cooler nails at 7 inches on center;
 For 5/8-inch gypsum board, No 11 gage (0.120 inch diameter) cooler nails at 7 inches on center;
 For gypsum sheathing board, 1-3/4 inches long by 7/16-inch head, diamond point galvanized nails at 4 inches on center;

FY 2010 LOS ANGELES REGION UNIFORM CODE PROGRAM (LARUCP)

For gypsum lath, No. 13 gage (0.092 inch) by 1-1/8 inches long, 19/64-inch head, plasterboard at 5 inches on center;

For Portland cement plaster, No. 11 gage (0.120 inch) by 1 1/2 inches long, 7/16-inch head at 6 inches on center;

~~For fiberboard and particleboard, No. 11 gage (0.120 inch) by 1 1/2 inches long, 7/16-inch head, galvanized nails at 3 inches on center.~~

d. S-W sheathing shall be a minimum of 15/32" thick nailed with 8d common placed 3/8 inches from panel edges and spaced not more than 6 inches on center and 12 inches on center along intermediate framing members.

RATIONALE:

This proposed amendment specifies minimum sheathing thickness and nail size and spacing so as to provide a uniform standard of construction for designers and buildings to follow. This is intended to improve the performance level of buildings and structures that are subject to the higher seismic demands placed on buildings or structure in this region. This proposed amendment reflects the recommendations by the Structural Engineers Association of Southern California (SEAOSC) and the Los Angeles City Joint Task Force that investigated the poor performance observed in 1994 Northridge Earthquake. This proposed amendment is a continuation of an amendment adopted during previous code adoption cycles.

FINDINGS:

Local Geological Conditions – The greater Los Angeles region is a densely populated area having buildings and structures constructed over and near a vast array of fault systems capable of producing major earthquakes, including but not limited to the recent 1994 Northridge Earthquake. Conventional framing does not address the need for a continuous load path, critical shear transfer mechanisms, connection-ties, irregular and flexible portions of complex shaped structures. The proposed modification to provide specific detailing requirements will improve the performance of buildings and structures and therefore needs to be incorporated into the code to assure that new buildings and additions to existing buildings are designed and constructed in accordance with the scope and objectives of the International Building Code.

FY 2010 LOS ANGELES REGION UNIFORM CODE PROGRAM (LARUCP)

2010 LARUCP 23-10. Section 2304.9.1 and Table 2304.9.1 of the 2010 Edition of the California Building Code are amended to read as follows:

2304.9.1 Fastener requirements. Connections for wood members shall be designed in accordance with the appropriate methodology in Section 2301.2. The number and size of fasteners connecting wood members shall not be less than that set forth in Table 2304.9.1. Staple fasteners in Table 2304.9.1 shall not be used to resist or transfer seismic forces in structures assigned to Seismic Design Category D, E or F.

Exception: Staples may be used to resist or transfer seismic forces when the allowable shear values are substantiated by cyclic testing and approved by the building official.

Add new footnote q to Table 2304.9.1.

q. Staples shall not be used to resist or transfer seismic forces in structures assigned to Seismic Design Category D, E or F.

RATIONALE:

Due to the high geologic activities in the Southern California area and the expected higher level of performance on buildings and structures, this proposed local amendment limit the use of staple fasteners in resisting or transferring seismic forces. In September 2007, limited cyclic testing data was provided to the ICC Los Angeles Chapter Structural Code Committee showing that stapled wood structural shear panels do not exhibit the same behavior as the nailed wood structural shear panels. The test results of the stapled wood structural shear panels appeared much lower in strength and drift than the nailed wood structural shear panel test results. Therefore, the use of staples as fasteners to resist or transfer seismic forces shall not be permitted without being substantiated by cyclic testing. This proposed amendment is a continuation of a similar amendment adopted during previous code adoption cycles.

FINDINGS:

Local Geological Conditions – The greater Los Angeles region is a densely populated area having buildings and structures constructed over and near a vast array of fault systems capable of producing major earthquakes, including but not limited to the recent 1994 Northridge Earthquake. The proposed modification to limit the use of staple fasteners to resist or transfer seismic load improve the performance of buildings and structures during a seismic event and therefore need to be incorporated into the code to assure that new buildings and structures and additions or alterations to existing buildings or structures are designed and constructed in accordance with the scope and objectives of the International Building Code.

2010 LARUCP 23-11. Section 2308.12.5 of the 2010 Edition of the California Building Code are amended to read as follows:

2308.12.5 Attachment of sheathing. Fastening of braced wall panel sheathing shall not be less than that prescribed in Table 2308.12.4 or 2304.9.1. Wall sheathing shall not be attached to framing members by adhesives. Staple fasteners in Table 2304.9.1 shall not be used to resist or transfer seismic forces in structures assigned to Seismic Design Category D, E or F.

Exception: Staples may be used to resist or transfer seismic forces when the allowable shear values are substantiated by cyclic testing and approved by the building official.

All braced wall panels shall extend to the roof sheathing and shall be attached to parallel roof rafters or blocking above with framing clips (18 gauge minimum) spaced at maximum 24 inches (6096 mm) on center with four 8d nails per leg (total eight 8d nails per clip). Braced wall panels shall be laterally braced at each top corner and at maximum 24 inches (6096 mm) intervals along the top plate of discontinuous vertical framing.

RATIONALE:

Due to the high geologic activities in the Southern California area and the expected higher level of performance on buildings and structures, this proposed local amendment limit the use of staple fasteners in resisting or transferring seismic forces. In September 2007, limited cyclic testing data was provided to the ICC Los Angeles Chapter Structural Code Committee showing that stapled wood structural shear panels do not exhibit the same behavior as the nailed wood structural shear panels. The test results of the stapled wood structural shear panels appeared much lower in strength and drift than the nailed wood structural shear panel test results. Therefore, the use of staples as fasteners to resist or transfer seismic forces shall not be permitted without being substantiated by cyclic testing. This proposed amendment is a continuation of a similar amendment adopted during previous code adoption cycles.

FINDINGS:

Local Geological Conditions – The greater Los Angeles region is a densely populated area having buildings and structures constructed over and near a vast array of fault systems capable of producing major earthquakes, including but not limited to the recent 1994 Northridge Earthquake. The proposed modification to limit the use of staple fasteners to resist or transfer seismic load improve the performance of buildings and structures during a seismic event and therefore need to be incorporated into the code to assure that new buildings and structures and additions or alterations to existing buildings or structures are designed and constructed in accordance with the scope and objectives of the International Building Code.

PART II

RECOMMENDED LARUCP AMENDMENTS TO THE 2010 EDITION OF THE CALIFORNIA RESIDENTIAL CODE

SUMMARY OF RECOMMENDED LARUCP AMENDMENTS TO THE 2010 CRC

2010 LARUCP NO.	TITLE/DESCRIPTION	STATUS ¹	DATE
R3-01	Amend CRC Section R301.1.3.2 Woodframe Structures	AS	6/24/10
R3-02	Amend CRC Section R301.1.4 Slopes Steeper Than 33%	AS	6/24/10
R3-03	Amend CRC Section R301.2.2.2.5 Irregular Buildings	AS	6/24/10
R3-04	Amend CRC Section R301.2.2.3.5.1 Modify AISI S230 Section B1	AS	6/24/10
R3-05	Amend CRC Section R322.1.4.1 Design Flood Elevations	AS	6/24/10
R4-01	Amend CRC Section R401.1 Foundation Application	AS	6/24/10
R4-02	Amend CRC Section R403.1 General Footings	AS	6/24/10
R4-03	Amend CRC Section R404.2 Wood Foundation Walls	AS	6/24/10
R5-01	Amend CRC Section R501.1 Application	AS	6/24/10
R5-02	Amend CRC Section R503.2.4 Openings In Horizontal Diaphragms	AM	6/24/10
R6-01	Amend CRC Table R602.3(1) Fastener Schedule	AS	5/25/10
R6-02	Amend CRC Table R602.3(2) Alternate Attachment	AM	5/25/10
R6-03	Amend CRC Table R602.10.1.2(2) Bracing Requirement	AS	5/25/10
R6-04	Amend CRC Table R602.10.2 Intermittent Bracing Method	AM	5/25/10
R6-05	Amend CRC Figure R602.10.3.2 Alternate Braced Wall Panel	AM	6/8/10
R6-06	Amend CRC Figure R602.10.3.3 Portal Frame	AM	6/8/10
R6-07	Amend CRC Section R602.10.3.3 Method PFH	AS	6/8/10
R6-08	Amend CRC Table R602.10.4.1 Continuous Sheathing	AM	6/8/10
R6-09	Amend CRC Figure R602.10.4.1.1 Method CS-PF	AS	6/24/10
R6-10	Delete CRC Section R602.10.7.1 Braced Wall Panel	AS	6/8/10
R6-11	Amend CRC Section R606.2.4 Parapet Walls	AS	6/8/10
R6-12	Amend CRC Section R606.12.2.2.3 Reinforcement for Masonry	AS	6/8/10
R6-13	Amend CRC Section R602.3.2 Single Top Plate	AS	6/24/10
R8-01	Amend CRC Table R802.5.1(9) Joist Heel Joint Connection	AM	6/24/10
R8-02	Amend CRC Section R802.8 Lateral Support	AS	6/24/10
R8-03	Amend CRC Section R802.10.2 Design of Wood Trusses	AS	6/24/10
R8-04	Add CRC Section R803.2.4 Openings in Horizontal Diaphragms	AS	6/24/10
R10-01	Amend CRC Section R1001.3.1 Vertical Reinforcing	AS	6/24/10

FOOTNOTE:

1. AS = Approved as submitted. AM = Approved as modified.

2010 LARUCP R3-01. Section R301.1.3.2 of the 2010 Edition of the California Residential Code is amended to read as follows:

R301.1.3.2 Woodframe structures ~~greater than two stories~~. The building official shall require construction documents to be approved and stamped by a California licensed architect or engineer for all dwellings of woodframe construction more than two stories and basement in height located in Seismic Design Category A, B or C. Notwithstanding other sections the law, the law establishing these provisions is found in Business and Professions Code Section 5537 and 6737.1.

The building official shall require construction documents to be approved and stamped by a California licensed architect or engineer for all dwellings of woodframe construction more than one story in height or with a basement located in Seismic Design Category D₀, D₁, D₂ or E.

RATIONALE:

After the 1994 Northridge Earthquake, the Wood Frame Construction Joint Task Force recommended that the quality of wood frame construction need to be greatly improved. One such recommendation identified by the Task Force is to improve the quality and organization of structural plans prepared by the engineer or architect so that plan examiners, building inspectors, contractors and special inspectors may logically follow and construct the presentation of the seismic force-resisting systems in the construction documents. For buildings or structures located in Seismic Design Category D₀, D₁, D₂ or E that are subject to a greater level of seismic forces, the requirement to have a California licensed architect or engineer prepare the construction documents is intended to minimize or reduce structural deficiencies that may cause excessive damage or injuries in wood frame buildings. Structural deficiencies such as plan and vertical irregularities, improper shear transfer of the seismic force-resisting system, missed details or connections important to the structural system, and the improper application of the prescriptive requirements of the California Residential Code can be readily addressed by a registered design professional.

FINDINGS:

Local Geological Conditions – The greater Los Angeles region is a densely populated area having buildings and structures constructed over and near a vast array of fault systems capable of producing major earthquakes, including but not limited to the recent 1994 Northridge Earthquake. The proposed modification to require construction documents for wood frame construction greater than one story in height or with a basement to be approved and stamped by a California licensed architect or engineer is intended to assure that the both the structural design and prescriptive requirement of the code are properly utilized and presented and therefore need to be incorporated into the code to assure that new buildings and structures and additions or alterations to existing buildings or structures are designed and constructed in accordance with the scope and objectives of the International Residential Code.

2010 LARUCP R3-02. Section R301.1.4 is added to Chapter 3 of the 2010 Edition of the California Residential Code to read as follows:

R301.1.4 Seismic design provisions for buildings constructed on or into slopes steeper than one unit vertical in three units horizontal (33.3 percent slope). The design and construction of new buildings and additions to existing buildings when constructed on or into slopes steeper than one unit vertical in three units horizontal (33.3 percent slope) shall comply with Section 1613.12 of the California Building Code.

RATIONALE:

Due to the difficulty of fire suppression vehicles accessing winding and narrow hillside properties and the probabilities for future earthquakes in the Los Angeles region, this technical amendment is required to address the special needs for buildings constructed on hillside locations. A joint Structural Engineers Association of Southern California (SEAOSC) and both the Los Angeles County and Los Angeles City Task Force investigated the performance of hillside building failures after the Northridge earthquake. Numerous hillside failures resulted in loss of life and millions of dollars in damage. These criteria were developed to minimize the damage to these structures and have been in use by both the City and County of Los Angeles for several years with much success. This proposed amendment is a continuation of an amendment adopted during previous code adoption cycles.

FINDINGS:

Local Topographical and Geological Conditions – The greater Los Angeles region is a densely populated area having buildings and structures constructed over and near a vast array of fault systems capable of producing major earthquakes, including but not limited to the recent 1994 Northridge Earthquake. Additionally, the topography within the Los Angeles region includes significant hillsides with narrow and winding access that makes timely response by fire suppression vehicles challenging and difficult. The proposed modification establishes design parameters to better mitigate and limit property damage that are the results of increased seismic forces which are imparted upon hillside buildings and structures and therefore need to be incorporated into the code to assure that new buildings and structures and additions or alterations to existing buildings or structures are designed and constructed in accordance with the scope and objectives of the International Residential Code.

2010 LARUCP R3-03. Section R301.2.2.2.5 of the 2010 Edition of the California Residential Code is amended to read as follows:

1. When exterior shear wall lines or braced wall panels are not in one plane vertically from the foundation to the uppermost story in which they are required.

Exception: For wood light frame construction, floors with cantilevers or setbacks not exceeding four times the nominal depth of the wood floor joists are permitted to support braced wall panels that are out of plane with braced wall panels below provided that:

- ~~1. Floor joists are nominal 2 inches by 10 inches (51 mm by 254 mm) or larger and spaced not more than 16 inches (406 mm) on center.~~
 - ~~2. The ratio of the back span to the cantilever is at least 2 to 1.~~
 - ~~3. Floor joists at ends of braced wall panels are doubled.~~
 - ~~4. For wood frame construction, a continuous rim joist is connected at ends to all cantilever joists. When spliced, the rim joists shall be spliced using a galvanized metal tie not less than 0.058 inch (1.5 mm) (16 gage) and 11/2 inches (38 mm) wide fastened with six 16d nails on each side of the splice or a block of the same size as the rim joist of sufficient length to fit securely between the joist space at which the splice occurs fastened with eight 16d nails on each side of the splice; and~~
 - ~~5. Gravity loads carried at the end of cantilevered joists are limited to uniform wall and roof loads and the reactions from headers having a span of 18 feet (2438 mm) or less.~~
3. When the end of a braced wall panel occurs over an opening in the wall below and ends at a horizontal distance greater than 1 foot (305 mm) from the edge of the opening. This provision is applicable to shear walls and braced wall panels offset in plane and to braced wall panels offset out of plane as permitted by the exception to item 1 above.

Exception: For wood light frame wall construction, one end of a braced wall panel shall be permitted to extend more than one foot (305 mm) over an opening not more than 8 feet (2438 mm) wide in the wall below provided that the opening includes a header in accordance with the following:

- ~~1. The building width, loading condition and framing member species limitations of Table R502.5(1) shall apply; and~~
 - ~~2. Not less than one 2x12 or two 2x10 for an opening not more than 4 feet (1219 mm) wide; or~~
 - ~~3. Not less than two 2x12 or three 2x10 for an opening not more than 6 feet (1829 mm) wide; or~~
 - ~~4. Not less than three 2x12 or four 2x10 for an opening not more than 8 feet (2438 mm) wide; and~~
 - ~~5. The entire length of the braced wall panel does not occur over an opening in the wall below.~~
5. When portions of a floor level are vertically offset.

Exceptions:

- ~~1. Framing supported directly by continuous foundations at the perimeter of the building.~~
- ~~2. For wood light frame construction, floors shall be permitted to be vertically offset when the floor framing is lapped or tied together as required by section R502.6.1.~~

RATIONALE:

With the higher seismic demand placed on buildings and structures in this region, precautionary steps are proposed to reduce or eliminate potential problems that may result by limiting the type of irregular conditions specified in the International Residential Code. Such limitations are intended to reduce the potential structural damage expected in the event of an earthquake. The cities and county of the Los Angeles region has taken extra measures to maintain the structural integrity of the framing of the shear walls and all associated elements when designed for high levels of seismic loads.

FINDINGS:

Local Geological Conditions – The greater Los Angeles region is a densely populated area having buildings and structures constructed over and near a vast array of fault systems capable of producing major earthquakes, including but not limited to the recent 1994 Northridge Earthquake. The proposed amendment limits the type of irregular conditions within buildings that may lead to higher structural damage during a seismic event and therefore needs to be incorporated into the code to assure that new buildings and structures and additions or alterations to existing buildings or structures are designed and constructed in accordance with the scope and objectives of the International Residential Code and consistent with the requirements in the ASCE 7-05.

2010 LARUCP R3-04. Section R301.2.2.3.5.1 is added to Section 301.2.2.3.5 of the 2010 Edition of the California Residential Code as follows:

R301.2.2.3.5.1 AISI S230, Section B1. Modify AISI S230, Section B1 to read as follows:

Where No. 8 screws are specified, the required number of screws in a steel-to-steel connection shall be permitted to be reduced in accordance with the reduction factors in Table B1-1 when larger screws are used or when ~~one of~~ the sheets of steel being connected is thicker than 33 mils (0.84mm). When applying the reduction factor, the resulting number of screws shall be rounded up.

RATIONALE:

The term “one” conflicts with Table B1-1, whereas in the table it states the “thinnest connected steel sheet”. The term “one” in the code language can misleadingly be interpreted as though one of the sheets can be 33 mils and the other sheet thicker, but that one would still qualify for a reduction factor; this is not the intent of the tables. For example, in a steel-to-steel connection consisting of a 33 mils and 44 mils, and if in any part of the code it is required to provide (4) No. 8 screws; according to Table B1-1 the factor 1.0 would apply to the required number of screws and thus a reduction of screws would not be allowed.

FINDINGS:

Local Geological Conditions – The greater Los Angeles region is a densely populated area having buildings and structures constructed over and near a vast array of fault systems capable of producing major earthquakes, including but not limited to the recent 1994 Northridge Earthquake. The proposed modification to clarify that the thinnest connected steel sheets need to be thicker than 33 mils to qualify for the reduction factors and therefore needs to be incorporated into the code to assure that new buildings and structures and additions or alterations to existing buildings or structures are designed and constructed in accordance with the scope and objectives of the International Residential Code.

2010 LARUCP R3-05. Section R322.1.4.1 of the 2010 Edition of the California Residential Code is amended to read as follows:

R322.1.4.1 Determination of design flood elevations. If design flood elevations are not specified, the building official is authorized to require the applicant to:

1. Obtain and reasonably use data available from a federal, state or other source; or
2. Determine the design flood elevation in accordance with accepted hydrologic and hydraulic undertaken by a registered ~~design professional~~ civil engineer who shall determine that the technical methods used reflect currently accepted engineering practice. Studies, analyses and computations shall be submitted insufficient detail to allow thorough review and approval.

RATIONALE:

This amendment is intended to clarify the appropriate design professional who should perform studies and analysis for design flood elevations. Registered civil engineers are highly trained and equipped to perform such design and analysis.

FINDINGS:

Local Topographical and Geological Conditions – The greater Los Angeles region is affected by both natural and man-made topographic conditions, such as, steep hillsides conditions where dry brush may cause brush fires and are fanned by strong concentrated winds caused by steep ravines and valley areas of the hillsides, or when it rains, mudflow or landslides caused by steep bare (no vegetation) slopes. Man-made topography may include very densely populated areas or areas of many high-rise buildings, including but not limited to, Century City, Wilshire Corridor, Westwood or Downtown Los Angeles, where street access for local fire department may be challenging and difficult to navigate or impeded during times of high traffic activity. The proposed modification to require a registered civil engineer to perform design and analysis ensures that a more reliable and better performance is achieved and therefore needs to be incorporated into the code to assure that new buildings and structures and additions or alternations to existing buildings or structures are designed and constructed in accordance with the scope and objectives of the International Residential Code.

2010 LARUCP R4-01. Section R401.1 of the 2010 Edition of the California Residential Code is amended to read as follows:

R401.1 Application. The provisions of this chapter shall control the design and construction of the foundation and foundation spaces for all buildings. In addition to the provisions of this chapter, the design and construction of foundations in areas prone to flooding as established by Table R301.2(1) shall meet the provisions of Section R322. Wood foundations shall be designed and installed in accordance with AF&PA PWF.

Exception: The provisions of this chapter shall be permitted to be used for wood foundations only in the following situations:

1. In buildings that have no more than two floors and a roof.
2. When interior basement and foundation walls are constructed at intervals not exceeding 50 feet (15 240 mm).

Wood foundations in Seismic Design Category D₀, D₁ or D₂ shall ~~be designed in accordance with accepted engineering practice~~ not be permitted.

Exception: In non-occupied, single-story, detached storage sheds and similar uses other than carport or garage, provided the gross floor area does not exceed 200 square feet, the plate height does not exceed 12 feet in height above the grade plane at any point, and the maximum roof projection does not exceed 24 inches.

RATIONALE:

No substantiating data has been provided to show that wood foundation is effective in supporting buildings and structures during a seismic event while being subject to deterioration caused by the combined detrimental effect of constant moisture in the soil and wood-destroying organisms. Wood foundation, when they are not properly treated and protected against deterioration, have performed very poorly and have led to slope failures. Most contractors are typically accustomed to construction in dry and temperate weather in the Southern California region and are not generally familiar with the necessary precautions and treatment of wood that makes it suitable for both seismic event and wet applications. The proposed amendment takes the precautionary steps to reduce or eliminate potential problems that may result in using wood foundation that experience relatively rapid decay due to the fact that the region does not experience temperatures cold enough to destroy or retard the growth and proliferation of wood-destroying organisms. However, an exception is made for non-occupied, single-story storage structures that pose significantly less risk to human safety and may utilize the wood foundation guidelines specified in this Chapter. This proposed amendment is a continuation of an amendment adopted during previous code adoption cycles for the California Building Code.

FINDINGS:

Local Climatic and Geological Conditions – The greater Los Angeles region is a densely populated area having buildings and structures constructed over and near a vast array of fault systems capable of producing major earthquakes, including but not limited to the recent 1994 Northridge Earthquake. In addition, the region is within a climate system capable of producing major winds, fire and rain related disasters, including but not limited to those caused by the Santa Ana winds and El Nino (or La Nina) subtropical-like weather. This region is especially susceptible to more active termite and wood attacking insects and microorganisms. The proposed modification to prohibit the use of wood foundation systems as well as limit prescriptive design provisions in an effort to mitigate potential problems or deficiencies due to the proliferation of wood-destroying organisms and therefore need to be incorporated into the code to assure that new buildings and structures and additions or alterations to existing buildings or structures are designed and constructed in accordance with the scope and objectives of the International Residential Code.

2010 LARUCP R4-02. Sections R403.1.2, R403.1.3, R403.1.5 of the 2010 Edition of the California Residential Code are amended to read as follows:

R403.1.2 Continuous footing in Seismic Design Categories D₀, D₁ and D₂. The braced wall panels at exterior walls of buildings located in Seismic Design Categories D₀, D₁ and D₂ shall be supported by continuous footings. All required interior braced wall panels in buildings ~~with plan dimensions greater than 50 feet (15240 mm)~~ shall also be supported by continuous footings.

R403.1.3 Seismic reinforcing. Concrete footings located in Seismic Design Categories D₀, D₁ and D₂, as established in Table R301.2(1), shall have minimum reinforcement. Bottom reinforcement shall be located a minimum of 3 inches (76 mm) clear from the bottom of the footing.

In Seismic Design Categories D₀, D₁ and D₂ where construction joint is created between a concrete footing and a stem wall, a minimum of one No. 4 bar shall be installed at not more than 4 feet (1219 mm) on center. The vertical bar shall extend to 3 inches (76 mm) clear of the bottom of the footing, have a standard hook and extend a minimum of 14 inches (357 mm) into the stem wall.

In Seismic Design Categories D₀, D₁ and D₂ where a grouted masonry stem wall is supported on a concrete footing and stem wall, a minimum of one No. 4 bar shall be installed at not more than 4 feet (1219 mm) on center. The vertical bar shall extend to 3 inches (76 mm) clear of the bottom of the footing and have a standard hook.

In Seismic Design Categories D₀, D₁ and D₂ masonry stem walls without solid grout and vertical reinforcing are not permitted.

Exception: In detached one- and two-family dwellings located in Seismic Design Category A, B or C which are three stories or less in height and constructed with stud bearing walls, plain concrete footings without longitudinal reinforcement supporting walls and isolated plain concrete footings supporting columns or pedestals are permitted.

R403.1.5 Slope. The top surface of footings shall be level. The bottom surface of footings shall be permitted to have a slope not exceeding one unit vertical in 10 units horizontal (10-percent slope). Footings shall be stepped where it is necessary to change the elevation of the top surface of the footing or where the surface of the ground slopes more than one unit vertical in 10 units horizontal (10-percent slope).

For structures located in Seismic Design Categories D₀, D₁ or D₂, stepped footings shall be reinforced with four 1/2-inch diameter (12.7 mm) deformed reinforcing bars. Two bars shall be place at the top and bottom of the footings as shown in Figure R403.1.5.

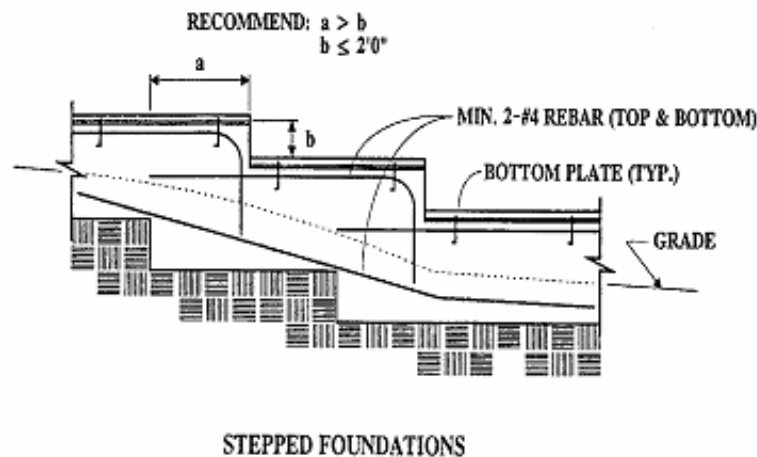

FIGURE R403.1.5
STEPPED FOOTING

RATIONALE:

With the higher seismic demand placed on buildings and structures in this region, precautionary steps are proposed to reduce or eliminate potential problems that may result for under-reinforced footings located on sloped surfaces. Requiring minimum reinforcement for stepped footings is intended to address the problem of poor performance of plain or under-reinforced footings during a seismic event. Furthermore, interior walls can easily be called upon to resist over half of the seismic loading imposed on simple buildings or structures. Without a continuous foundation to support the braced wall line, seismic loads would be transferred through other elements such as non-structural concrete slab floors, wood floors, etc. The proposed change is to limit the use of the exception to structures assigned to Seismic Design Category A, B or C where lower seismic demands are expected. Requiring interior braced walls be supported by continuous foundations is intended to reduce or eliminate the poor performance of buildings or structures. This proposed amendment is consistent with an amendment adopted during previous code adoption cycles for the California Building Code.

FINDINGS:

Local Geological Conditions – The greater Los Angeles region is a densely populated area having buildings and structures constructed over and near a vast array of fault systems capable of producing major earthquakes, including but not limited to the recent 1994 Northridge Earthquake. The proposed modification to require continuous footings under braced wall lines, require reinforcement in one- and two-family dwelling, and minimum reinforcement in stepped footings will improve performance of buildings or structure during a seismic event and minimize potential problems or deficiencies and therefore need to be incorporated into the code to assure that new buildings and additions to existing buildings are designed and constructed in accordance with the scope and objectives of the International Residential Code.

2010 LARUCP R4-03. Section R404.2 of the 2010 Edition of the California Residential Code is amended to read as follows:

R404.2 Wood foundation walls. Wood foundation walls shall be constructed in accordance with the provisions of Sections R404.2.1 through R404.2.6 and with the details shown in Figures R403.1(2) and R403.2(3). Wood foundation walls shall not be used for structures located in Seismic Design Category D₀, D₁ or D₂.

RATIONALE:

No substantiating data has been provided to show that wood foundation wall is effective in supporting buildings and structures during a seismic event while being subject to deterioration caused by the combined detrimental effect of constant moisture in the soil and wood-destroying organisms. Wood foundation walls, when they are not properly treated and protected against deterioration, have performed very poorly and have led to slope failures. Most contractors are typically accustomed to construction in dry and temperate weather in the Southern California region and are not generally familiar with the necessary precautions and treatment of wood that makes it suitable for both seismic event and wet applications. The proposed amendment takes the precautionary steps to reduce or eliminate potential problems that may result in using wood foundation walls that experience relatively rapid decay due to the fact that the region does not experience temperatures cold enough to destroy or retard the growth and proliferation of wood-destroying organisms. This proposed amendment is consistent with an amendment adopted during previous code adoption cycles for the California Building Code.

FINDINGS:

Local Climatic and Geological Conditions – The greater Los Angeles region is a densely populated area having buildings and structures constructed over and near a vast array of fault systems capable of producing major earthquakes, including but not limited to the recent 1994 Northridge Earthquake. In addition, the region is within a climate system capable of producing major winds, fire and rain related disasters, including but not limited to those caused by the Santa Ana winds and El Nino (or La Nina) subtropical-like weather. This region is especially susceptible to more active termite and wood attacking insects and microorganisms. The proposed modification to prohibit the use of wood foundation wall in an effort to mitigate potential problems or deficiencies due to the proliferation of wood-destroying organisms and therefore need to be incorporated into the code to assure that new buildings and structures and additions or alterations to existing buildings or structures are designed and constructed in accordance with the scope and objectives of the International Residential Code.

2010 LARUCP R5-01. Section R501.1 of the 2010 Edition of the California Residential Code is amended to read as follows:

R501.1 Application. The provision of this chapter shall control the design and construction of the floors for all buildings including the floors of attic spaces used to house mechanical or plumbing fixtures and equipment weighing less than 400 lbs and maximum height of 4 feet above the floor or attic level.

RATIONALE:

There is no limitation for weight of mechanical and plumbing fixtures and equipments in the International Residential Code. Requirements from ASCE 7-05 and the International Building Code would permit equipment weighing up to 400 lbs when mounted at 4 feet or less above the floor or attic level without engineering design. Where equipment exceeds this requirement, it is the intent of this proposed amendment that a registered design professional be required to analyze if the floor support is adequate and structurally sound.

FINDINGS:

Local Geological Conditions – The greater Los Angeles region is a densely populated area having buildings and structures constructed over and near a vast array of fault systems capable of producing major earthquakes, including but not limited to the recent 1994 Northridge Earthquake. The proposed modification to limit the equipment weight is intended to reduce injuries, save lives, and minimize structural damages and therefore needs to be incorporated into the code to assure that new buildings and structures and additions or alterations to existing buildings or structures are designed and constructed in accordance with the scope and objectives of the International Residential Code.

2010 LARUCP R5-02. Section R503.2.4 is added to Chapter 5 of the 2010 Edition of the California Residential Code to read as follows:

R503.2.4 Openings in horizontal diaphragms. Openings in horizontal diaphragms with a dimension perpendicular to the joist that is greater than 4 feet (1.2 m) shall be constructed in accordance with Figure R503.2.4.

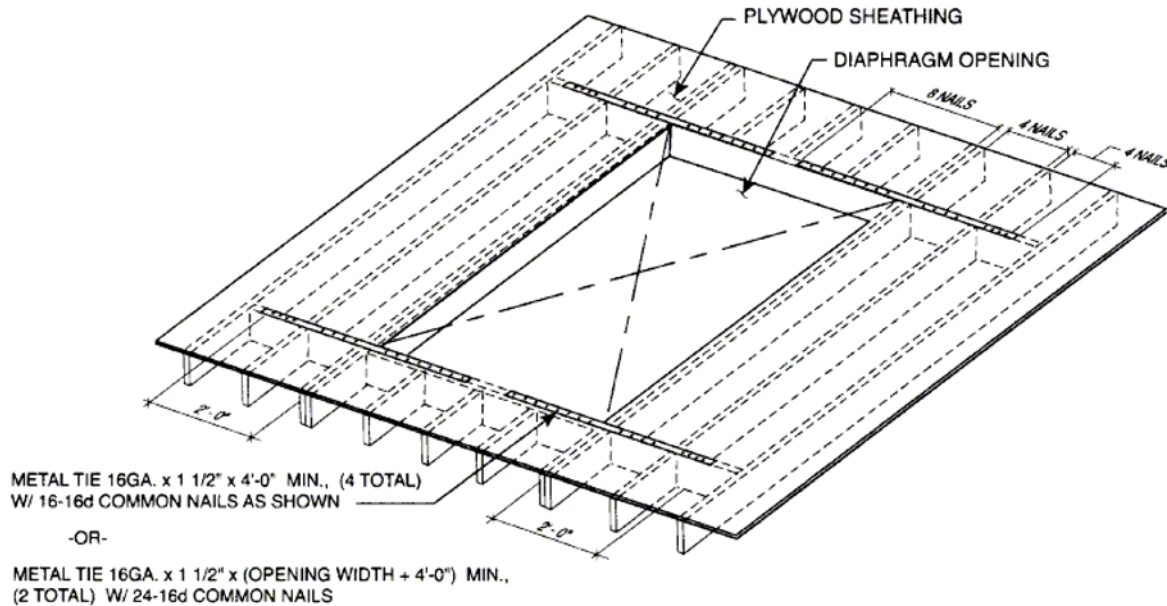

For SI: 1 inch = 25.4 mm, 1 foot = 304.8 mm.

- a. Blockings shall be provided beyond headers.
- b. Metal ties not less than 0.058 inch [1.47 mm (16 galvanized gage)] by 1.5 inches (38 mm) wide with eight 16d common nails on each side of the header-joist intersection. The metal ties shall have a minimum yield of 33,000 psi (227 MPa).
- c. Openings in diaphragms shall be further limited in accordance with Section R301.2.2.2.5.

FIGURE R503.2.4
OPENINGS IN HORIZONTAL DIAPHRAGMS

RATIONALE:

Section R502.10 of the Code does not provide any prescriptive criteria to limit the maximum floor opening size nor does Section R503 provide any details to address the issue of shear transfer near larger floor openings. With the higher seismic demand placed on buildings and structures in this region, it is important to ensure that a complete load path is provided to reduce or eliminate potential damages caused by seismic forces. Requiring blocking with metal ties around larger floor openings and limiting opening size is consistent with the requirements of Section R301.2.2.2.5.

FINDINGS:

Local Geological Conditions – The greater Los Angeles region is a densely populated area having buildings and structures constructed over and near a vast array of fault systems capable of producing major earthquakes, including but not limited to the recent 1994 Northridge Earthquake. The proposed modification to require specific detailing at large floor openings is intended to address the poor

performance of floor diaphragms with openings and limit or reduce property damages during a seismic event and therefore needs to be incorporated into the code to assure that new buildings and structures and additions or alterations to existing buildings or structures are designed and constructed in accordance with the scope and objectives of the International Residential Code.

FY 2010 LOS ANGELES REGION UNIFORM CODE PROGRAM (LARUCP)

2010 LARUCP R6-01. Lines 34 thru 37 of Table R602.3(1) of the 2010 Edition of the California Residential Code are amended to read as follows:

Other wall sheathing^h				
34	$\frac{1}{2}$ " structural cellulose fiberboard sheathing	$\frac{1}{2}$ " galvanized roofing nail, $\frac{7}{16}$ " crown or 1" crown staple 16 ga., $\frac{1}{4}$" long	3	6
35	$\frac{25}{32}$ " structural cellulose fiberboard sheathing	$\frac{3}{4}$ " galvanized roofing nail, $\frac{7}{16}$ " crown or 1" crown staple 16 ga., $\frac{1}{2}$" long	3	6
36	$\frac{1}{2}$ " gypsum sheathing ^d	$\frac{1}{2}$ " galvanized roofing nail, staple galvanized, $\frac{1}{2}$" long, $\frac{1}{4}$" screws, Type W or S	7	7
37	$\frac{5}{8}$ " gypsum sheathing ^d	$\frac{3}{4}$ " galvanized roofing nail, staple galvanized, $\frac{5}{8}$" long, $\frac{5}{8}$" screws, Type W or S	7	7

RATIONALE:

The Structural Engineers Association of Southern California (SEAOSC) and the Los Angeles City Joint Task Force that investigated the damages to buildings and structures during the 1994 Northridge Earthquake recommended reducing allowable shear values in wood structural panel shear walls or diaphragms that were not substantiated by cyclic testing. That recommendation was consistent with a report to the Governor from the Seismic Safety Commission of the State of California recommending that code requirements be "more thoroughly substantiated with testing." The allowable shear values for wood structural panel shear walls or diaphragms fastened with staples are based on monotonic testing and does not take into consideration that earthquake forces load shear wall or diaphragm in a repeating and fully reversible manner.

In September 2007, limited cyclic testing was conducted by a private engineering firm to determine if wood structural panels fastened with staples would exhibit the same behavior as the wood structural panels fastened with common nails. The test result revealed that wood structural panel fastened with staples appeared to be much lower in strength and stiffness than wood structural panels fastened with common nails. It was recommended that the use of staples as fasteners for wood structural panel shear walls or diaphragms not be permitted to resist seismic forces in structures assigned to Seismic Design Category D₀, D₁ and D₂ unless it can be substantiated by cyclic testing.

This proposed amendment is consistent with an amendment adopted during previous code adoption cycles for the California Building Code.

FINDINGS:

Local Geological Conditions – The greater Los Angeles region is a densely populated area having buildings and structures constructed over and near a vast array of fault systems capable of producing major earthquakes, including but not limited to the recent 1994 Northridge Earthquake. The proposed modification to place design and construction limits on staples as fasteners used in wood structural panel or diaphragms not substantiated with cyclic testing will help to maintain minimum quality of construction and performance standards of structures and therefore need to be incorporated into the code to assure that new buildings and structures and additions or alterations to existing buildings or structures are designed and constructed in accordance with the scope and objectives of the International Residential Code.

FY 2010 LOS ANGELES REGION UNIFORM CODE PROGRAM (LARUCP)

2010 LARUCP R6-02. Table R602.3(2) of the 2010 Edition of the California Residential Code is amended to read as follows:

Wood structural panels subfloor, roof and wall sheathing to framing and particleboard wall sheathing to framing^f			
up to 1/2	Staple 15 ga. 1 3/4	4	8
	0.097 - 0.099 Nail 2 1/4	3	6
	Staple 16 ga. 1 3/4	3	6
19/32 and 5/8	0.113 Nail 2	3	6
	Staple 15 and 16 ga. 2	4	8
	0.097 - 0.099 Nail 2 1/4	4	8
23/32 and 3/4	Staple 14 ga. 2	4	8
	Staple 15 ga. 1 3/4	3	6
	0.097 - 0.099 Nail 2 1/4	4	8
	Staple 16 ga. 2	4	8
1	Staple 14 ga. 2 1/4	4	8
	0.113 Nail 2 1/4	3	6
	Staple 15 ga. 2 1/4	4	8

Floor underlayment; plywood-hardboard-particleboard^f			
Plywood			
1/4 and 5/16	1 1/4" ring or screw shank nail-minimum 12 1/2 ga. (0.099") shank diameter	3	6
	Staple 18 ga., 7/8" 3/16" crown width	2	5
11/32, 3/8, 15/32, and 1/2	1 1/4" ring or screw shank nail-minimum 12 1/2 ga. (0.099") shank diameter	6	8 ^e
19/32, 5/8, 23/32 and 3/4	1 1/2" ring or screw shank nail-minimum 12 1/2 ga. (0.099") shank diameter	6	8
	Staple 16 ga. 1 1/2	6	8

RATIONALE:

The Structural Engineers Association of Southern California (SEAOSC) and the Los Angeles City Joint Task Force that investigated the damages to buildings and structures during the 1994 Northridge Earthquake recommended reducing allowable shear values in wood structural panel shear walls or diaphragms that were not substantiated by cyclic testing. That recommendation was consistent with a report to the Governor from the Seismic Safety Commission of the State of California recommending that code requirements be "more thoroughly substantiated with testing." The allowable shear values for wood structural panel shear walls or diaphragms fastened with staples are based on monotonic testing and does not take into consideration that earthquake forces load shear wall or diaphragm in a repeating and fully reversible manner.

In September 2007, limited cyclic testing was conducted by a private engineering firm to determine if wood structural panels fastened with staples would exhibit the same behavior as the wood structural panels fastened with common nails. The test result revealed that wood structural panel fastened with staples appeared to be much lower in strength and stiffness than wood structural panels fastened with common nails. It was recommended that the use of staples as fasteners for wood structural panel shear walls or diaphragms not be permitted to resist seismic forces in structures assigned to Seismic Design Category D₀, D₁ and D₂ unless it can be substantiated by cyclic testing.

This proposed amendment is consistent with an amendment adopted during previous code adoption cycles for the California Building Code.

FINDINGS:

Local Geological Conditions – The greater Los Angeles region is a densely populated area having buildings and structures constructed over and near a vast array of fault systems capable of producing major earthquakes, including but not limited to the recent 1994 Northridge Earthquake. The proposed modification to place design and construction limits on staples as fasteners used in wood structural panel or diaphragms not substantiated with cyclic testing will help to maintain minimum quality of construction and performance standards of structures and therefore need to be incorporated into the code to assure that new buildings and structures and additions or alterations to existing buildings or structures are designed and constructed in accordance with the scope and objectives of the International Residential Code.

FY 2010 LOS ANGELES REGION UNIFORM CODE PROGRAM (LARUCP)

2010 LARUCP R6-03. Table R602.10.1.2(2) of the 2010 Edition of the California Residential Code is amended to read as follows:

**TABLE R602.10.1.2(2)^{a, b, c}
BRACING REQUIREMENTS BASED ON SEISMIC DESIGN CATEGORY
(AS A FUNCTION OF BRACED WALL LINE LENGTH)**

SOIL CLASS D ^a WALL HEIGHT = 10 FT 10 PSF FLOOR DEAD LOAD 15 PSF ROOF/CEILING DEAD LOAD BRACED WALL LINE SPACING ≤ 25 FT			MINIMUM TOTAL LENGTH (feet) OF BRACED WALL PANELS REQUIRED ALONG EACH BRACED WALL LINE			
Seismic Design Category (SDC)	Story Location	Braced Wall Line Length	Method LIB	Methods ^d DWB, SFB, GB, PBS, PCP, HPS	Method WSP	Continuous Sheathing

SDC D ₀ or D ₁		10	NP	3.0 6.0	2.0	1.7
		20	NP	6.0 12.0	4.0	3.4
		30	NP	9.0 18.0	6.0	5.1
		40	NP	12.0 24.0	8.0	6.8
		50	NP	15.0 30.0	10.0	8.5
		10	NP	6.0 NP	4.5	3.8
		20	NP	12.0 NP	9.0	7.7
		30	NP	18.0 NP	13.5	11.5
		40	NP	24.0 NP	18.0	15.3
		50	NP	30.0 NP	22.5	19.1
		10	NP	8.5 NP	6.0	5.1
		20	NP	17.0 NP	12.0	10.2
		30	NP	25.5 NP	18.0	15.3
		40	NP	34.0 NP	24.0	20.4
		50	NP	42.5 NP	30.0	25.5

SDC D ₂		10	NP	4.0 8.0	2.5	
		20	NP	8.0 16.0	5.0	
		30	NP	12.0 24.0	7.5	
		40	NP	16.0 32.0	10.0	
		50	NP	20.0 40.0	12.5	
		10	NP	7.5 NP	5.5	
		20	NP	15.0 NP	11.0	
		30	NP	22.5 NP	16.5	
		40	NP	30.0 NP	22.0	
		50	NP	37.5 NP	27.5	
		10	NP	NP	NP	
		20	NP	NP	NP	
		30	NP	NP	NP	
		40	NP	NP	NP	
		50	NP	NP	NP	

d. Methods GB and PCP braced wall panel h/w ratio shall not exceed 1:1 in SDC D₀, D₁, and D₂. Methods DWB, SFB, PBS, and HPS are not permitted in SDC D₀, D₁, and D₂.

RATIONALE:

Due to the high geologic activities in the Southern California area and the expected higher level of performance on buildings and structures, this proposed local amendment increase the length and limits the location where shear walls sheathed with lath, plaster or gypsum board are used in multi-level





buildings. In addition, shear walls sheathed with other materials are prohibited in Seismic Design Category D₀, D₁ and D₂ to be consistent with the design limitation for similar shear walls found in the California Building Code. The poor performance of such shear walls in the 1994 Northridge Earthquake was investigated by the Structural Engineers Association of Southern California (SEAOSC) and the Los Angeles City Task Force and formed the basis for this proposed amendment. Considering that shear walls sheathed with lath, plaster or gypsum board are less ductile than steel moment frames or wood structural panel shear walls, the cities and county of the Los Angeles region has taken the necessary measures to limit the potential structural damage that may be caused by the use of such walls at the lower level of multi-level building that are subject to higher levels of seismic loads. This proposed amendment is consistent with an amendment adopted during previous code adoption cycles for the California Building Code.

FINDINGS:

Local Geological Conditions – The greater Los Angeles region is a densely populated area having buildings and structures constructed over and near a vast array of fault systems capable of producing major earthquakes, including but not limited to the recent 1994 Northridge Earthquake. The proposed modification to increase the length and limit the location where shear walls sheathed with lath, plaster or gypsum board are used will help to ensure that multi-level building will reach it's performance objective in resisting higher levels of seismic loads and therefore need to be incorporated into the code to assure that new buildings and structures and additions or alterations to existing buildings or structures are designed and constructed in accordance with the scope and objectives of the International Residential Code.

2010 LARUCP R6-04. Table R602.10.2 of the 2010 Edition of the California Residential Code is amended to read as follows:

TABLE R602.10.2
INTERMITTENT BRACING METHODS^a

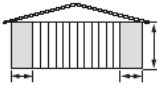
				8d common (2 1/2" x 0.131) nails at 6" spacing (panel edge) at 12" spacing (intermediate supports), 3/8" edge distance to panel edge
WSP	Wood structural panel (see Section R604)	$\frac{3}{8}$ " 15/32"		For exterior interior sheathing see Table R602.3(3) For interior sheathing see Table R602.3(1)
SFB	Structural fiberboard sheathing	1/2" or 25/32" for maximum 16" stud spacing		1 1/2" galvanized roofing nails or 8d common (2 1/2" x 0.131) nails at 3" spacing (panel edges) at 6" spacing (intermediate supports)
GB	Gypsum board	1/2"		Nails or screws at 7" spacing at panel edges including top and bottom plates; for all braced wall panel locations for exterior sheathing nail or screw size, see Table R602.3(1); for interior gypsum board nail or screw size, see Table R702.3.5
PBS	Particleboard sheathing (see Section R605)	3/8" or 1/2" for maximum 16" stud spacing		1 1/2" galvanized roofing nails or 8d common (2 1/2" x 0.131) nails at 3" spacing (panel edges) at 6" spacing (intermediate supports)
PCP	Portland cement plaster	See Section R703.6 For maximum 16" stud spacing		1 1/2", 11 gage, 7/16" head nails at 6" spacing or 7/8", 16 gage staples at 6" spacing

a. Methods GB and PCP braced wall panel h/w ratio shall not exceed 1:1 in SDC D₀, D₁, and D₂. Methods LIB, DWB, SFB, PBS, HPS, and PFG are not permitted in SDC D₀, D₁, and D₂.

RATIONALE:

3/8" thick 3 ply-plywood shear walls experienced many failures during the Northridge Earthquake. Box nails were observed to cause massive and multiple failures of the typical 3/8" thick 3-ply plywood during the Northridge Earthquake. This proposed amendment specifies minimum sheathing thickness, nail size and spacing so as to provide a uniform standard of construction for designers and buildings to follow. This is intended to improve the performance level of buildings and structures that are subject to the higher seismic demands and reduce and limit potential damages to property. This proposed amendment reflects the recommendations by the Structural Engineers Association of Southern California (SEAOSC) and the Los Angeles City Joint Task Force that investigated the poor performance observed in 1994 Northridge Earthquake.

In September 2007, limited cyclic testing was conducted by a private engineering firm to determine if wood structural panels fastened with staples would exhibit the same behavior as the wood structural panels fastened with common nails. The test result revealed that wood structural panel fastened with staples appeared to be much lower in strength and stiffness than wood structural panels fastened with common nails. It was recommended that the use of staples as fasteners for wood structural panel shear walls or diaphragms not be permitted to resist seismic forces in structures assigned to Seismic Design Category D₀, D₁ and D₂ unless it can be substantiated by cyclic testing.

This proposed amendment is consistent with an amendment adopted during previous code adoption cycles for the California Building Code.

FINDINGS:

Local Geological Conditions – The greater Los Angeles region is a densely populated area having buildings and structures constructed over and near a vast array of fault systems capable of producing major earthquakes, including but not limited to the recent 1994 Northridge Earthquake. The proposed modification to place design and construction limits on stapled nail fasteners used in wood structural panel shear walls not substantiated with cyclic testing and requiring minimum sheathing thickness and nailing type and size will help to maintain minimum quality of construction and performance standards of structures and therefore need to be incorporated into the code to assure that new buildings and additions to existing buildings are designed and constructed in accordance with the scope and objectives of the International Residential Code.

2010 LARUCP R6-05. Figure R602.10.3.2 of the 2010 Edition of the California Residential Code is amended to read as follows:

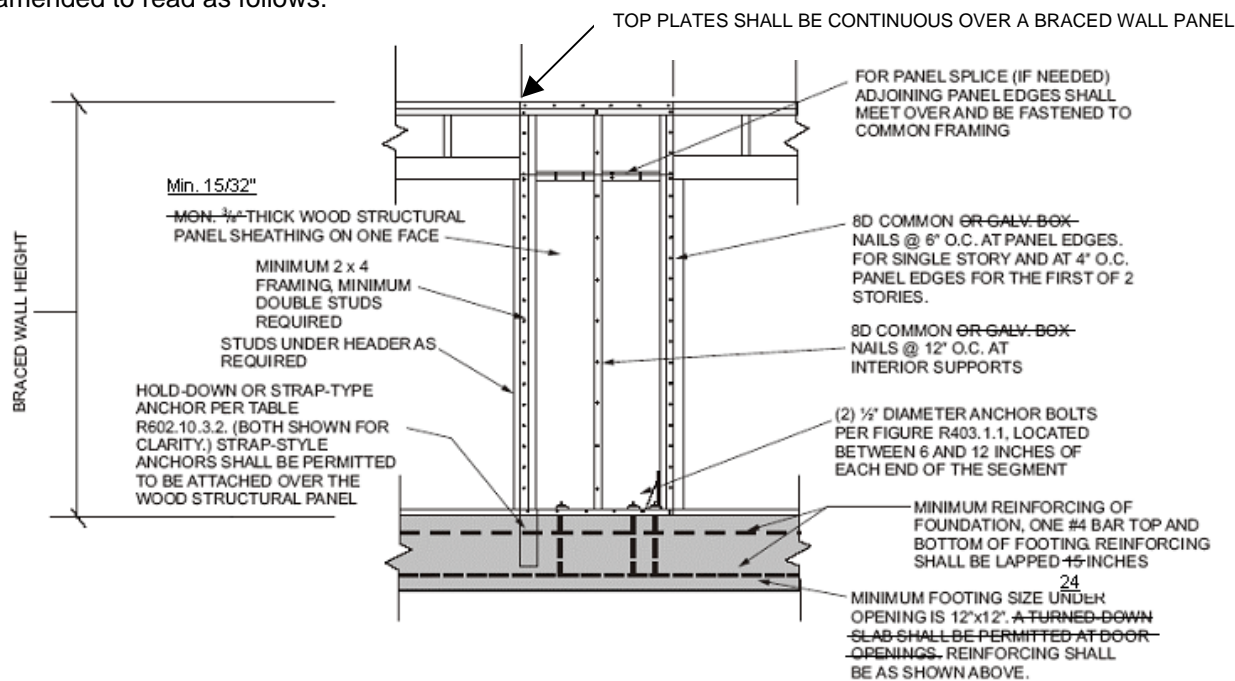

**FIGURE R602.10.3.2
ALTERNATE BRACED WALL PANEL**

RATIONALE:

3/8" thick 3 ply-plywood shear walls experienced many failures during the Northridge Earthquake. Box nails were observed to cause massive and multiple failures of the typical 3/8" thick 3-ply plywood during the Northridge Earthquake. This proposed amendment specifies minimum sheathing thickness, nail size and spacing so as to provide a uniform standard of construction for designers and buildings to follow. This is intended to improve the performance level of buildings and structures that are subject to the higher seismic demands and reduce and limit potential damages to property. This proposed amendment reflects the recommendations by the Structural Engineers Association of Southern California (SEAOSC) and the Los Angeles City Joint Task Force that investigated the poor performance observed in 1994 Northridge Earthquake. This proposed amendment is consistent with an amendment adopted during previous code adoption cycles for the California Building Code.

FINDINGS:

Local Geological Conditions – The greater Los Angeles region is a densely populated area having buildings and structures constructed over and near a vast array of fault systems capable of producing major earthquakes, including but not limited to the recent 1994 Northridge Earthquake. The proposed modification requiring minimum sheathing thickness and nailing type and size will help to maintain minimum quality of construction and performance standards of structures and therefore need to be incorporated into the code to assure that new buildings and additions to existing buildings are designed and constructed in accordance with the scope and objectives of the International Residential Code.

2010 LARUCP R6-06. Figure R602.10.3.3 of the 2010 Edition of the California Residential Code is amended to read as follows:

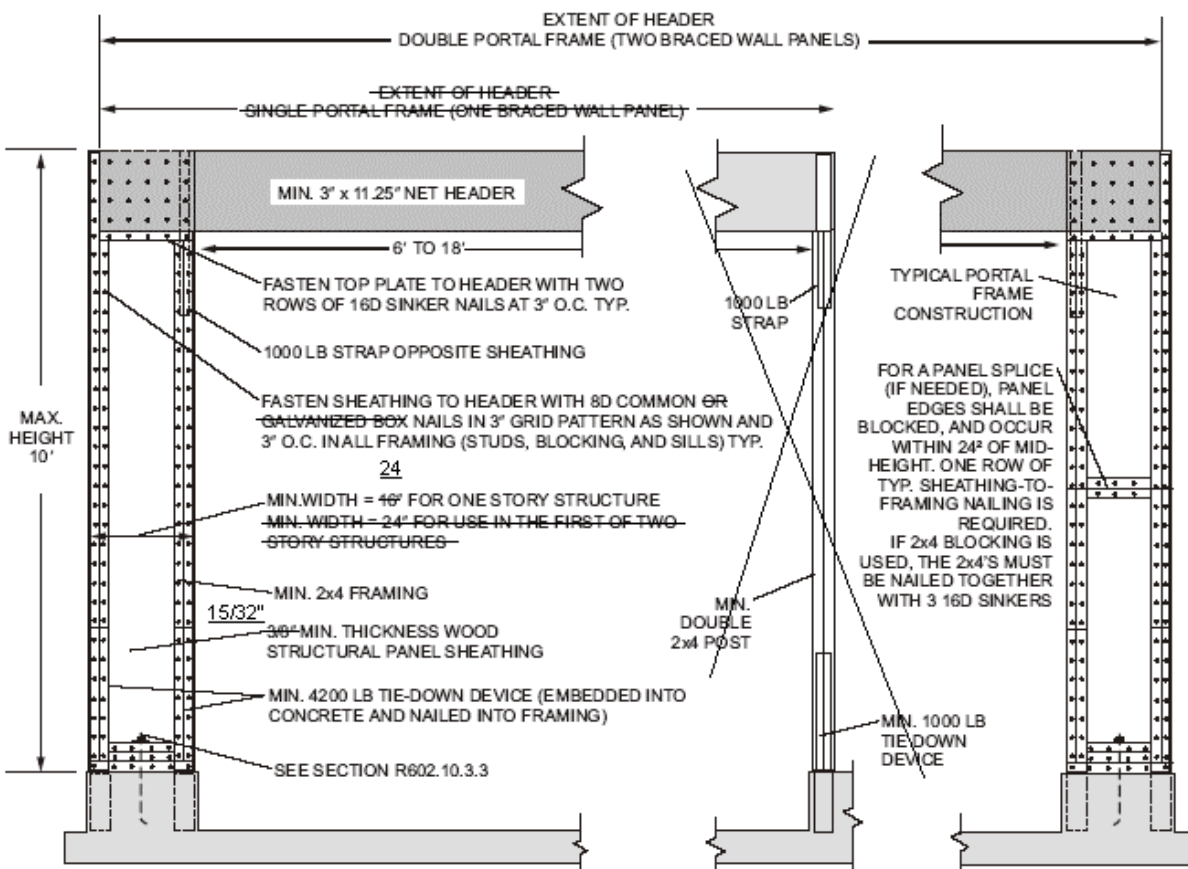

FIGURE R602.10.3.3

METHOD PFH: PORTAL FRAME WITH HOLD-DOWNS AT DETACHED GARAGE DOOR OPENINGS

RATIONALE:

3/8" thick 3 ply-plywood shear walls experienced many failures during the Northridge Earthquake. Box nails were observed to cause massive and multiple failures of the typical 3/8" thick 3-ply plywood during the Northridge Earthquake. This proposed amendment specifies minimum sheathing thickness, nail size and spacing so as to provide a uniform standard of construction for designers and buildings to follow. This is intended to improve the performance level of buildings and structures that are subject to the higher seismic demands and reduce and limit potential damages to property. This proposed amendment reflects the recommendations by the Structural Engineers Association of Southern California (SEAOSC) and the Los Angeles City Joint Task Force that investigated the poor performance observed in 1994 Northridge Earthquake. This proposed amendment is consistent with an amendment adopted during previous code adoption cycles for the California Building Code.

FINDINGS:

Local Geological Conditions – The greater Los Angeles region is a densely populated area having buildings and structures constructed over and near a vast array of fault systems capable of producing major earthquakes, including but not limited to the recent 1994 Northridge Earthquake. The proposed modification requiring minimum sheathing thickness and nailing type and size will help to maintain

minimum quality of construction and performance standards of structures and therefore need to be incorporated into the code to assure that new buildings and additions to existing buildings are designed and constructed in accordance with the scope and objectives of the International Residential Code.

2010 LARUCP R6-07. Item 1 of Section R602.10.3.3 of the 2010 Edition of the California Residential Code is amended to read as follows:

1. Each panel shall be fabricated in accordance with Figure R602.10.3.3. The wood structural panel sheathing shall extend up over the solid sawn or glued-laminated header and shall be nailed in accordance with Figure R602.10.3.3. A spacer, if used with a built-up header, shall be placed on the side of the built-up beam opposite the wood structural panel sheathing. The header shall extend between the inside faces of the first full-length outer studs of each panel. One anchor bolt not less than 5/8-inch-diameter (16 mm) and installed in accordance with Section R403.1.6 shall be provided in the center of each sill plate. The hold-down devices shall be an embedded-strap type, installed in accordance with the manufacturer's recommendations. The panels shall be supported directly on a foundation that is continuous across the entire length of the braced wall line. The foundation shall be reinforced as shown on Figure R602.10.3.2. This reinforcement shall be lapped not less than ~~45~~²⁴ inches (~~384~~ 610 mm) with the reinforcement required in the continuous foundation located directly under the braced wall line.

RATIONALE:

The proposal change to the minimum lap splice requirement ensures design and construction consistency with Section 12.16.1 of ACI 318-05.



FINDINGS:

Local Geological Conditions – The greater Los Angeles region is a densely populated area having buildings and structures constructed over and near a vast array of fault systems capable of producing major earthquakes, including but not limited to the recent 1994 Northridge Earthquake. The proposed modification to increase the lap splice requirement will improve performance of buildings and structures and is consistent with ACI 318 and therefore need to be incorporated into the code to assure that new buildings and structures and additions or alterations to existing buildings or structures are designed and constructed in accordance with the scope and objectives of the International Residential Code and ACI 318.

FY 2010 LOS ANGELES REGION UNIFORM CODE PROGRAM (LARUCP)

2010 LARUCP R6-08. Table R602.10.4.1 of the 2010 Edition of the California Residential Code is amended to read as follows:

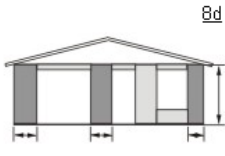
**TABLE R602.10.4.1
CONTINUOUS SHEATHING METHODS**

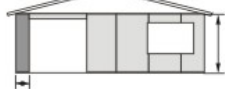
METHOD	MATERIAL	MINIMUM THICKNESS	FIGURE	CONNECTION CRITERIA
CS-WSP	Wood structural panel	$\frac{15}{32}"$ $\frac{3}{8}"$		6d common (2" x 0.113") nails at 6" spacing (panel edges) and at 12" spacing (intermediate supports) or 16 ga. x 1 3/4" staples at 3" spacing (panel edges) and 6" spacing (intermediate supports)
CS-G	Wood structural panel adjacent to garage openings and supporting roof load only ^{a,b}	$\frac{15}{32}"$ $\frac{3}{8}"$		See Method CS-WSP
CS-PF	Continuous portal frame	See Section R602.10.4.1.1		See Section R602.10.4.1.1

RATIONALE:

3/8" thick 3 ply-plywood shear walls experienced many failures during the Northridge Earthquake. Box nails were observed to cause massive and multiple failures of the typical 3/8" thick 3-ply plywood during the Northridge Earthquake. This proposed amendment specifies minimum sheathing thickness, nail size and spacing so as to provide a uniform standard of construction for designers and buildings to follow. This is intended to improve the performance level of buildings and structures that are subject to the higher seismic demands and reduce and limit potential damages to property. This proposed amendment reflects the recommendations by the Structural Engineers Association of Southern California (SEAOSC) and the Los Angeles City Joint Task Force that investigated the poor performance observed in 1994 Northridge Earthquake.

In September 2007, limited cyclic testing was conducted by a private engineering firm to determine if wood structural panels fastened with staples would exhibit the same behavior as the wood structural panels fastened with common nails. The test result revealed that wood structural panel fastened with staples appeared to be much lower in strength and stiffness than wood structural panels fastened with common nails. It was recommended that the use of staples as fasteners for wood structural panel shear walls or diaphragms not be permitted to resist seismic forces in structures assigned to Seismic Design Category D₀, D₁ and D₂ unless it can be substantiated by cyclic testing.

This proposed amendment is consistent with an amendment adopted during previous code adoption cycles for the California Building Code.

FINDINGS:

Local Geological Conditions – The greater Los Angeles region is a densely populated area having buildings and structures constructed over and near a vast array of fault systems capable of producing major earthquakes, including but not limited to the recent 1994 Northridge Earthquake. The proposed modification to place design and construction limits on stapled nail fasteners used in wood structural panel shear walls not substantiated with cyclic testing and requiring minimum sheathing thickness and nailing type and size will help to maintain minimum quality of construction and performance standards of structures and therefore need to be incorporated into the code to assure that new buildings and additions

to existing buildings are designed and constructed in accordance with the scope and objectives of the International Residential Code.

2010 LARUCP R6-09. Figure R602.10.4.1.1 of the 2010 Edition of the California Residential Code is amended to read as follows:

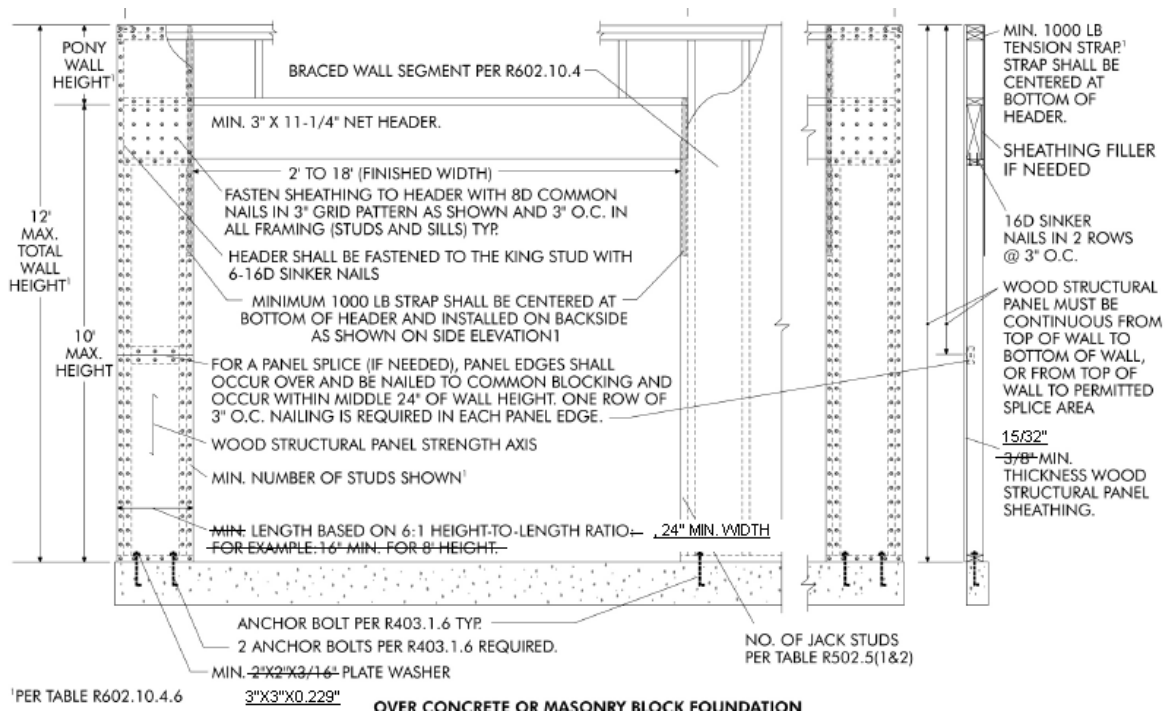

RATIONALE:

3/8" thick 3 ply-plywood shear walls experienced many failures during the Northridge Earthquake. Box nails were observed to cause massive and multiple failures of the typical 3/8" thick 3-ply plywood during the Northridge Earthquake. This proposed amendment specifies minimum sheathing thickness, nail size and spacing so as to provide a uniform standard of construction for designers and buildings to follow. This is intended to improve the performance level of buildings and structures that are subject to the higher seismic demands and reduce and limit potential damages to property. This proposed amendment reflects the recommendations by the Structural Engineers Association of Southern California (SEAOSC) and the Los Angeles City Joint Task Force that investigated the poor performance observed in 1994 Northridge Earthquake. This proposed amendment is consistent with an amendment adopted during previous code adoption cycles for the California Building Code.

FINDINGS:

Local Geological Conditions – The greater Los Angeles region is a densely populated area having buildings and structures constructed over and near a vast array of fault systems capable of producing major earthquakes, including but not limited to the recent 1994 Northridge Earthquake. The proposed modification requiring minimum sheathing thickness and nailing type and size will help to maintain minimum quality of construction and performance standards of structures and therefore need to be incorporated into the code to assure that new buildings and additions to existing buildings are designed and constructed in accordance with the scope and objectives of the International Residential Code.

2010 LARUCP R6-10. Section R602.10.7.1 of the 2010 Edition of the California Residential Code is deleted in its entirety:

~~**R602.10.7.1 Braced wall panel support for Seismic Design Category D₂.** In one-story buildings located in Seismic Design Category D₂, braced wall panels shall be supported on continuous foundations at intervals not exceeding 50 feet (15 240 mm). In two-story buildings located in Seismic Design Category D₂, all braced wall panels shall be supported on continuous foundations.~~

~~**Exception:** Two-story buildings shall be permitted to have interior braced wall panels supported on continuous foundations at intervals not exceeding 50 feet (15 240 mm) provided that:~~

- ~~1. The height of cripple walls does not exceed 4 feet (1219 mm).~~
- ~~2. First-floor braced wall panels are supported on doubled floor joists, continuous blocking or floor beams.~~
- ~~3. The distance between bracing lines does not exceed twice the building width measured parallel to the braced wall line.~~

RATIONALE:

With the higher seismic demand placed on buildings and structures in this region, interior walls can easily be called upon to resist over half of the seismic loading imposed on simple buildings or structures. Without a continuous foundation to support the braced wall line, seismic loads would be transferred through other elements such as non-structural concrete slab floors, wood floors, etc. Requiring interior braced walls be supported by continuous foundations is intended to reduce or eliminate the poor performance of buildings or structures. This proposed amendment is consistent with an amendment adopted during previous code adoption cycles for the California Building Code.

FINDINGS:

Local Geological Conditions – The greater Los Angeles region is a densely populated area having buildings and structures constructed over and near a vast array of fault systems capable of producing major earthquakes, including but not limited to the recent 1994 Northridge Earthquake. The proposed modification to require all exterior walls and interior braced wall panels in buildings be supported on continuous footings for a complete load path will improve performance of buildings or structure during a seismic event and therefore, need to be incorporated into the code to assure that new buildings and structures and additions or alterations to existing buildings or structures are designed and constructed in accordance with the scope and objectives of the International Residential Code.

2010 LARUCP R6-11. Section R606.2.4 of the 2010 Edition of the California Residential Code is amended to read as follows:

R606.2.4 Parapet walls. Unreinforced solid masonry parapet walls shall not be less than 8 inches (203 mm) thick and their height shall not exceed four times their thickness. Unreinforced hollow unit masonry parapet walls shall be not less than 8 inches (203 mm) thick, and their height shall not exceed three times their thickness. Masonry parapet walls in areas subject to wind loads of 30 pounds per square foot (1.44 kPa) or located in Seismic Design Category D₀, D₁ or D₂, or on townhouses in Seismic Design Category C shall be reinforced in accordance with Section R606.12.

RATIONALE:

The addition of the word “or” will prevent the use of unreinforced parapets in Seismic Design Category D₀, D₁ or D₂, or on townhouses in Seismic Design Category C.

FINDINGS:

Local Geological Conditions – The greater Los Angeles region is a densely populated area having buildings and structures constructed over and near a vast array of fault systems capable of producing major earthquakes, including but not limited to the recent 1994 Northridge Earthquake. The proposed modification to not allow the use of unreinforced masonry is intended to prevent non-ductile failures and sudden structural collapses and therefore needs to be incorporated into the code to assure that new buildings and structures and additions or alterations to existing buildings or structures are designed and constructed in accordance with the scope and objectives of the International Residential Code.

2010 LARUCP R6-12. Section R606.12.2.2.3 of the 2010 Edition of the California Residential Code is amended to read as follows:

R606.12.2.2.3 Reinforcement of requirements for masonry elements. Masonry elements listed in Section R606.12.2.2.2 shall be reinforced in either the horizontal or vertical direction as shown in Figure ~~R606.11(2)~~R606.11(3) and in accordance with the following:

1. Horizontal reinforcement. Horizontal joint reinforcement shall consist of ~~at least two longitudinal W1.7 wires spaced not more than 16 inches (406 mm) for walls greater than 4 inches (102 mm) in width and at least one longitudinal W1.7 wire spaced not more than 16 inches (406 mm) for walls not exceeding 4 inches (102 mm) in width; or at least one No. 4 bar spaced not more than 48 inches (1219 mm).~~ Where two longitudinal wires of joint reinforcement are used, the space between these wires shall be the widest that the mortar joint will accommodate. Horizontal reinforcement shall be provided within 16 inches (406 mm) of the top and bottom of these masonry elements.
2. Vertical reinforcement. Vertical reinforcement shall consist of at least one No. 4 bar spaced not more than 48 inches (1219 mm). Vertical reinforcement shall be within ~~46-8~~ inches (406mm) of the ends of masonry walls.

RATIONALE:

Reinforcement using longitudinal wires for buildings and structures located in high seismic areas are deficient and not as ductile as deformed rebar. Having vertical reinforcement closer to the ends of masonry walls helps to improve the seismic performance of masonry buildings and structures.

FINDINGS:

Local Geological Conditions – The greater Los Angeles region is a densely populated area having buildings and structures constructed over and near a vast array of fault systems capable of producing major earthquakes, including but not limited to the recent 1994 Northridge Earthquake. The proposed modification to increase reinforcements will ensure that the ductility requirements for buildings in high seismic region meet the intent of the code and limit potential property damages and therefore need to be incorporated into the code to assure that new buildings and structures and additions or alterations to existing buildings or structures are designed and constructed in accordance with the scope and objectives of the International Residential Code.

2010 LARUCP R6-13. Exception of Section 602.3.2 of the 2010 Edition of the California Residential Code is amended to read as follows:

Exception: In other than Seismic Design Category D₀, D₁ or D₂, a—A single top plate may be installed in stud walls, provided the plate is adequately tied at joints, corners and intersecting walls by a minimum 3-inch-by-6-inch by a 0.036-inch-thick (76 mm by 152 mm by 0.914 mm) galvanized steel plate that is nailed to each wall or segment of wall by six 8d nails on each side, provided the rafters or joists are centered over the studs with a tolerance of no more than 1 inch (25 mm). The top plate may be omitted over lintels that are adequately tied to adjacent wall sections with steel plates or equivalent as previously described.

RATIONALE:

The cities and county of the Los Angeles region have taken extra measures to maintain the structural integrity of the framing of the shear wall system for buildings and structures subject to high seismic loads by eliminating single top plate construction. The performance of modern day braced wall panel construction is directly related to an adequate load path extending from the roof diaphragm to the foundation system. A single top plate is likely to be over nailed due to the nailing requirements at a rafter, stud, top plate splice, and braced wall panel edge in a single location. In addition, notching on a single top plate for plumbing, ventilation and electrical wiring may reduce the load transfer capacity of the plate without proper detailing. Majority of buildings and structures designed and built per the California Residential Code with a single top plate may not need structural observation and special inspections. The potential construction mistakes mentioned above could not be caught and corrected by knowledgeable engineers and inspectors, and could jeopardize structural performance of buildings and structures located in high seismic areas.

FINDINGS:

Local Geological Conditions – The greater Los Angeles region is a densely populated area having buildings and structures constructed over and near a vast array of fault systems capable of producing major earthquakes, including but not limited to the recent 1994 Northridge Earthquake. The proposed modification to eliminate the usage of a single top plate will help to maintain minimum quality of construction and performance standards of structures and therefore need to be incorporated into the code to assure that new buildings and structures and additions or alterations to existing buildings or structures are designed and constructed in accordance with the scope and objectives of the International Residential Code.

2010 LARUCP R8-01. Footnote “i” is added to Table R802.5.1(9) of the 2010 Edition of the California Residential Code to read as follows:

i. Edge distances, end distances and spacings for nails shall be sufficient to prevent splitting of the wood.

RATIONALE:

The number of nails required for the heel joint connection per Table R802.5.1(9) can be excessive depending on the rafter slope, spacing, and roof span. This footnote is intended to help prevent the splitting of connecting wood members when large numbers of nail are required as stated in the National Design Specification for Wood Construction (NDS).

FINDINGS:

Local Geological Conditions – The greater Los Angeles region is a densely populated area having buildings and structures constructed over and near a vast array of fault systems capable of producing major earthquakes, including but not limited to the recent 1994 Northridge Earthquake. The proposed modification to require connecting members to be of sufficient size will help to prevent splitting of connecting wood members and therefore need to be incorporated into the code to assure that new buildings and structures and additions or alterations to existing buildings or structures are designed and constructed in accordance with the scope and objectives of the International Residential Code.

2010 LARUCP R8-02. Section R802.8 of the 2010 Edition of the California Residential Code is amended to read as follows:

R802.8 Lateral support. Roof framing members and ceiling joists having a depth-to-thickness ratio exceeding $\frac{5}{2}$ to 1 based on nominal dimensions shall be provided with lateral support at points of bearing to prevent rotation. For roof rafters with ceiling joists attached per Table R602.3(1), the depth-thickness ratio for the total assembly shall be determined using the combined thickness of the rafter plus the attached ceiling joist.

RATIONALE:

This proposed amendment provides provisions to ensure that the ends of wood members and the points of bearing have adequate lateral support to prevent rotation and to help stabilize the members during construction. This proposed amendment is consistent with and similar to requirements contained in the National Design Specification for Wood Construction (NDS).

FINDINGS:

Local Geological Conditions – The greater Los Angeles region is a densely populated area having buildings and structures constructed over and near a vast array of fault systems capable of producing major earthquakes, including but not limited to the recent 1994 Northridge Earthquake. The proposed modification to provide lateral bracing at the ends of members will prevent rotation and stabilize the members during construction and therefore need to be incorporated into the code to assure that new buildings and structures and additions or alterations to existing buildings or structures are designed and constructed in accordance with the scope and objectives of the International Residential Code.

2010 LARUCP R8-03. Section R802.10.2 of the 2010 Edition of the California Residential Code is amended to read as follows:

R802.10.2 Design. Wood trusses shall be designed in accordance with accepted engineering practice. The design and manufacture of metal-plate-connected wood trusses shall comply with ANSI/TPI 1. The truss design drawings shall be prepared by a registered professional ~~where required by the statutes of the jurisdiction in which the project is to be constructed in accordance with Section R106.4.~~

RATIONALE:

Wood trusses are engineered structural elements that require engineered design and calculations. This amendment provides clarifications that all wood truss design drawings are to be prepared by a registered professional.

FINDINGS:

Local Geological Conditions – The greater Los Angeles region is a densely populated area having buildings and structures constructed over and near a vast array of fault systems capable of producing major earthquakes, including but not limited to the recent 1994 Northridge Earthquake. The proposed modification to require a registered design professional will help ensure the proper design of wood trusses and therefore need to be incorporated into the code to assure that new buildings and structures and additions or alterations to existing buildings or structures are designed and constructed in accordance with the scope and objectives of the International Residential Code.

2010 LARUCP R8-04. Section R803.2.4 is added to Chapter 8 of the 2010 Edition of the California Residential Code to read as follows:

R803.2.4 Openings in horizontal diaphragms. Openings in horizontal diaphragms shall conform with Section R503.2.4.

RATIONALE:

Section R802 of the Code does not provide any prescriptive criteria to limit the maximum roof opening size nor does Section R803 provide any details to address the issue of shear transfer near larger roof openings. With the higher seismic demand placed on buildings and structures in this region, it is important to ensure that a complete load path is provided to reduce or eliminate potential damages caused by seismic forces. Requiring blocking with metal ties around larger roof openings and limiting opening size is consistent with the requirements of Section R301.2.2.2.5.

FINDINGS:

Local Geological Conditions – The greater Los Angeles region is a densely populated area having buildings and structures constructed over and near a vast array of fault systems capable of producing major earthquakes, including but not limited to the recent 1994 Northridge Earthquake. The proposed modification to require specific detailing at large roof openings is intended to address the poor performance of roof diaphragms with openings and limit or reduce property damages during a seismic event and therefore needs to be incorporated into the code to assure that new buildings and structures and additions or alterations to existing buildings or structures are designed and constructed in accordance with the scope and objectives of the International Residential Code.

2010 LARUCP R10-01. Section R1001.3.1 of the 2010 Edition of the California Residential Code is amended to read as follows:

R1001.3.1 Vertical reinforcing. For chimneys up to 40 inches (1016 mm) wide, four No. 4 continuous vertical bars adequately anchored into the concrete foundation shall be placed between wythes of solid masonry or within the cells of hollow unit masonry and grouted in accordance with Section R609. Grout shall be prevented from bonding with the flue liner so that the flue liner is free to move with thermal expansion. For chimneys more than 40 inches (1016 mm) wide, two additional No. 4 vertical bars adequately anchored into the concrete foundation shall be provided for each additional flue incorporated into the chimney or for each additional 40 inches (1016 mm) in width or fraction thereof.

RATIONALE:

The performance of fireplace/chimney without anchorage to the foundation has been observed to be inadequate during major earthquakes. The lack of anchorage to the foundation can result in the overturning or displacement of the fireplace/chimney.

FINDINGS:

Local Geological Conditions – The greater Los Angeles region is a densely populated area having buildings and structures constructed over and near a vast array of fault systems capable of producing major earthquakes, including but not limited to the recent 1994 Northridge Earthquake. The proposed modification to anchor masonry chimneys into concrete foundation will reduce injuries, save lives, and minimize structural damages and therefore needs to be incorporated into the code to assure that new buildings and structures and additions or alterations to existing buildings or structures are designed and constructed in accordance with the scope and objectives of the International Residential Code.

PART III

RECOMMENDED LARUCP AMENDMENTS TO THE 2010 EDITION OF THE CALIFORNIA GREEN BUILDING STANDARDS CODE

SUMMARY OF RECOMMENDED LARUCP AMENDMENTS TO THE 2010 CGBSC

2010 LARUCP NO.	TITLE/DESCRIPTION	STATUS ¹	DATE
G1-01	Amend CGBSC Section 101.10 Mandatory and Voluntary Requirements	AM	6/24/10
G1-02	Add CGBSC Section 101.12 Fee for Mandatory Measures	AS	6/24/10
G1-03	Add CGBSC Section 101.12.1 Fee for Tier Measures	AS	6/24/10
G2-01	Amend CGBSC Section 202 Sustainability Definition	AS	6/24/10
G2-02	Amend CGBSC Section 202 Low-Rise Residential Building Definition	AM	6/24/10
G4-01	Amend CGBSC Section 4.304.1 Irrigation Controller	AM	6/24/10
G4-02	Amend CGBSC Section 4.408 Construction Waste Reduction	AS	6/24/10

FOOTNOTE:

1. AS = Approved as submitted. AM = Approved as modified.

2010 LARUCP G1-01. Section 101.10 of the 2010 Edition of the California Green Building Standards Code is amended to read as follows:

101.10 Mandatory and voluntary requirements. This code contains both mandatory and voluntary green building measures. Mandatory and voluntary measures are identified in the appropriate application checklist contained in this code. The mandatory measures of Chapter 4 and voluntary measures of Appendix A4 shall apply to new low-rise residential buildings. The mandatory measures of Chapter 5 and voluntary measures of Appendix A5 shall apply to all buildings which are not low-rise residential buildings.

RATIONALE:

Under the existing definition of Low-Rise Residential Building, measures in the California Green Building Standards Code would not be applicable to new residential buildings and structures four stories and greater. With the proposed amendment for Low-Rise Residential Building, this proposed amendment would allow application of the measures in Chapter 5 and Appendix Chapter A5 for new residential buildings greater than six stories. This proposed amendment would also allow applicability Chapter 5 and Appendix Chapter A5 to OSHPD 3 occupancies.

FINDINGS:

Local Environmental/Climatic Conditions – The greater Los Angeles region is a densely populated area having residential buildings constructed within a region where environmental resources are scarce due to varying and occasional immoderate temperatures and weather conditions. The proposed modification to require higher efficiencies of energy usage and greater beneficial use of environmental material will be achieved with the proposed expansion of the Mandatory and Voluntary requirements and therefore need to be incorporated into the code to assure that new residential buildings are designed and constructed in accordance with the scope and objectives of the California Green Building Standards Code.

FY 2010 LOS ANGELES REGION UNIFORM CODE PROGRAM (LARUCP)

2010 LARUCP G1-02. Section 101.12 is added to the 2010 California Green Building Standards Code to read as follows:

101.12 Fee for Mandatory Measures. A fee of ten percent (10%) of the plan check/permit fee shall be assessed to verify compliance with the mandatory measure of the California Green Building Standards Code.

OR ALTERNATIVELY

2010 LARUCP G1-02. Section [INSERT NUMBER] is added to the [INSERT NAME OF CITY] Municipal Code to read as follows:

[INSERT SECTION NUMBER] Fee for Mandatory Measures. A fee of ten percent (10%) of the plan check/permit fee shall be assessed to verify compliance with the mandatory measure of the California Green Building Standards Code.

RATIONALE:

Due to the extra work it will take staff to review and verify compliance with the measures in the new code, a recommended fee of 10% of either the permit and plan check is proposed. While it is understood that each jurisdiction must determine what fee is appropriate for their jurisdiction, the recommended 10% is a starting point. This amount is based upon similar fees assessed for other supplemental reviews or inspection such as accessibility or energy compliance. It may be used as a basis for justifying the proposed fees based upon comparison to other similar fees as indicated above.

FINDINGS:

Local Administrative Finding – This amendment is necessary for administrative clarification and does not modify a Building Standards pursuant to Sections 17958, 17958.5 and 17958.7 of the California Health and Safety Code. This amendment establishes administrative standards for the effective enforcement of building standards and therefore need to be incorporated into the code to assure that new buildings and structures and additions or alterations to existing buildings or structures are designed and constructed in accordance with the scope and objectives of the California Green Building Standards Code.

FY 2010 LOS ANGELES REGION UNIFORM CODE PROGRAM (LARUCP)

2010 LARUCP G1-03. Section 101.12.1 is added to the 2010 California Green Building Standards Code to read as follows:

101.12.1 Fee for Tier Measures. When Tier 1 or Tier 2 measures need to be verified by the enforcing agency, an additional ten percent (10%) of the plan check/permit fee may be assessed.

OR ALTERNATIVELY

2010 LARUCP G1-02. Section [INSERT NUMBER] is added to the [INSERT NAME OF CITY] Municipal Code to read as follows:

[INSERT SECTION NUMBER] Fee for Tier Measures. When Tier 1 or Tier 2 measures need to be verified by the enforcing agency, an additional ten percent (10%) of the plan check/permit fee may be assessed.

RATIONALE:

Due to the extra work it will take staff to review and verify compliance with the tier 1 or 2 measures in the new code, a recommended fee of 10% of either the permit and plan check is proposed. While it is understood that each jurisdiction must determine what fee is appropriate for their jurisdiction, the recommended 10% is a starting point. This amount is based upon similar fees assessed for other supplemental reviews or inspection such as accessibility or energy compliance. It may be used as a basis for justifying the proposed fees based upon comparison to other similar fees as indicated above.

FINDINGS:

Local Administrative Finding – This amendment is necessary for administrative clarification and does not modify a Building Standards pursuant to Sections 17958, 17958.5 and 17958.7 of the California Health and Safety Code. This amendment establishes administrative standards for the effective enforcement of building standards and therefore need to be incorporated into the code to assure that new buildings and structures and additions or alterations to existing buildings or structures are designed and constructed in accordance with the scope and objectives of the California Green Building Standards Code.

2010 LARUCP G2-01. Section 202 of the 2010 Edition of the California Green Building Standards Code is amended to read as follows:

LOW-RISE RESIDENTIAL BUILDING. A building that is of Occupancy Group R and is ~~three~~six stories or less, or that is a one- or two-family dwelling or townhouse.

RATIONALE:

Under the existing definition of Low-Rise Residential Building, measures in the California Green Building Standards Code would not be applicable to new residential buildings and structures four stories and greater. This proposed amendment would allow application of the measures in Chapter 4 and Appendix Chapter A4 for new residential buildings and structures six stories and less.

FINDINGS:

Local Environmental/Climatic Conditions – The greater Los Angeles region is a densely populated area having residential buildings constructed within a region where environmental resources are scarce due to varying and occasional immoderate temperatures and weather conditions. The proposed modification to require higher efficiencies of energy usage and greater beneficial use of environmental material will be achieved with the proposed expansion of Low Rise Residential Building and therefore need to be incorporated into the code to assure that new residential buildings are designed and constructed in accordance with the scope and objectives of the California Green Building Standards Code.

2010 LARUCP G2-02. Section 202 of the 2010 Edition of the California Green Building Standards Code is amended to read as follows:

SUSTAINABILITY. Consideration of present development and construction impacts on the community, the economy, and the environment without compromising the needs of the future.

RATIONALE:

The 2010 California Green Building Standards Code contains the word “sustainable” but does not define it. Although it is a term used in association with green building, the word “sustainability” is often confused to mean the same as green building. The proposed amendment allows clarity and distinguishing understanding while providing for a general definition.

FINDINGS:

Local Administrative Finding – This amendment is necessary for administrative clarification and does not modify a Building Standards pursuant to Sections 17958, 17958.5 and 17958.7 of the California Health and Safety Code. This amendment establishes administrative standards for the effective enforcement of building standards and therefore need to be incorporated into the code to assure that new buildings and structures and additions or alterations to existing buildings or structures are designed and constructed in accordance with the scope and objectives of the California Green Building Standards Code.

2010 LARUCP G4-01. Section 4.304.1 of the 2010 Edition of the California Green Building Standards Code is amended to read as follows:

4.403.1 Irrigation controllers. Automatic irrigation system controllers for landscaping provided by the builder and installed at the time of final inspection and shall comply with the following:

1. Controllers shall be weather- or soil moisture-based controllers that automatically adjust irrigation in response to changes in plants' needs as weather conditions change.
2. Weather-based controllers without integral rain sensors or communication systems that account for local rainfall shall have a separate wired or wireless rain sensor which connects or communicates with the controller(s). Soil moisture-based controllers are not required to have rain sensor input.

RATIONALE:

The proposed amendment requires that weather-based or soil moisture-based irrigation controllers shall be provided regardless of which entity provides and installs landscaping. The proposed amendment will then capture a larger number of landscaping projects with greater flexibility for water savings. The existing code requirement that conditions a smart controller when landscaping is provided and installed at the time of final inspection will remain as it appears in the California Green Building Standards Code.

FINDINGS:

Local Environmental/Climatic Conditions – The greater Los Angeles region is a densely populated area having residential buildings constructed within a region where water resource is scarce. The proposed modification to install weather-based or soil moisture-based irrigation controllers for any new residential building subject to Chapter 4, regardless of which entity provides landscaping, will allow greater efficiencies of outdoor water-use and therefore need to be incorporated into the code to assure that new residential buildings are designed and constructed in accordance with the scope and objectives of the California Green Building Standards Code.

2010 LARUCP G4-02. Section 4.408 of the 2010 Edition of the California Green Building Standards Code is amended to read as follows:

No recommended language provided.
[INSERT YOUR OWN LANGUAGE]

RATIONALE:

Each jurisdiction is recommended to evaluate and compare their existing Construction and Debris Recycling Ordinance, if applicable, against the requirements in this Section for applicability, duplication, or recommend change to their local ordinance. Since each jurisdiction may contain different requirement based upon their locally adopted ordinance, no recommended language is provided.

FINDINGS:

Local Environmental/Climatic Conditions – The greater Los Angeles region [OR NAME OF CITY OR REGION] is a densely populated area having buildings and structures constructed within [SPECIFY ENVIRONMENTAL CONDITIONS AND WHAT IMPACT IT HAS ON THE ENVIRONMENT]. The proposed modification to [SPECIFY PROPOSED REQUIREMENT AND WHAT IT HOPES TO ACCOMPLISH] and therefore need to be incorporated into the code to assure that new buildings and structures and additions or alterations to existing buildings or structures are designed and constructed in accordance with the scope and objectives of the California Green Building Standards Code.